



GAOHONGTE
AUTO PARTS

**Commercial vehicles / Industrial machinery
Agricultural machinery / Marine**

PRODUCT CATALOGUE



Guangdong Gaohong Trading Co., Ltd.

Add: Floor 1-7, Building T6, PCI Park, No.30 Kaitai Avenue,
Huangpu District, Guangzhou, China
Tel: +86 158 9142 7559
Email: info@gaohongtrade.com
Website: aimoparts.com

Focus On Power Cleaning

Editon 4

3000+
Filter Types

98%
Vehicle Models

25 Years
R&D Experience

APPLICATION

 Commercial vehicles

 Agricultural machinery

 Industrial machinery

 Marine



R & D CAPABILITY



R&D team members have years of experience in filter development and fuel system development. The company has world-class research and development equipment, Computer-aided design, three dimensional structure, digita-analog design. Design standards are ISO19438, ISO4020, ISO16332, ISO4538 and SAE J1488 and other international standards.



Long-term cooperative laboratory / national authoritative laboratory
 Bengbu Product Quality Supervision and Inspection Institute-<Air filter>
 Aviation Industry Measurement Technology Co.,Ltd.-<Fuel filter>
 National Remanufactured Auto Parts Product Supervision and Inspection Center-<Reliability test>

HONORS



Certification

Certificate of Honor

INVENTION PATENTS



■ PRODUCTS



Oil Filter



Fuel Filter



Air Dryer Cartridge



Hydrogen Energy Filter



Hydraulic Filter



Air Filter





Focus on power cleaning



CONTENT

001	Oil / Fuel Filter
001 American Series	
001 Freightliner Series	006 Caterpillar Series
011 Mack Series	013 Daf Series
015 Ford Series	018 John Deere Series
020 Thermo King & Carrier Series	
022 European Series	
022 Volvo Series	026 Mercedes-Benz Series
030 Scania Series	032 JCB Series
034 New Holland Series	036 Perkins Series
038 Iveco Series	041 Renault Series
043 Kamaz	
044 Japanese / Korean Series	
044 Isuzu Series	047 Komatsu Series
050 Hino Series	052 Mitsubishi Series
054 Hyundai Series	
056 Others	
062	Hydraulic Filter
067	Air Dryer Cartridge
069	Air Filter
076	Assembly
079	Accessory
079 Aluminum Base	082 Water Bowl

OIL / FUEL FILTER

AMERICAN SERIES

FREIGHTLINER



MJF-014

OE NO.: P552100
Size: Φ119*263
Thread: 1.5/8-12
Application: FREIGHTLINER, DETROIT DIESEL, INTERNATIONAL, KÄSSBOHRER, KENWORTH, LINK BELT

FLEETGUARD: LF3620
HENGST: H302W
MANN: W12102
BALDWIN: B495
DONALDSON: P552100



MJF-002

OE NO.: LF3000
Size: Φ119*299
Thread: 2 1/4-12
Application: FORD Cargo, Ww Constellation, FREIGHTLINER, DAF, Kenworth; Cummins Engines

FLEETGUARD: LF3000
HENGST: H300W03
MANN: WP12300
BALDWIN: 8D103
DONALDSON: P553000



MCC-038

OE NO.: 23530707
Size: Φ93.5*173
Thread: 13/16-12
Application: Detroit Diesel Engines, FREIGHTLINER, INTERNATIONAL

FLEETGUARD: FF5206 / FF5690
HENGST: H180WK
MANN: WK 950/12
BALDWIN: BF5810
DONALDSON: P556916 / P556917



MCC-093

OE NO.: FFS319
Size: Φ94.5*237
Thread: 1-14
Application: Caterpillar Engines, Ford, Freightliner, International, Kenworth, Peterbilt, Sterling, Western Star Trucks

FLEETGUARD: FFS319
HENGST: H175WK
MANN: WK980/1
BALDWIN: BF7587
DONALDSON: P551319



MJE-038

OE NO.: LF667
Size: Φ110*263
Thread: 1 1/8-16
Application: FREIGHTLINER+Trucks & Buses, Mack, Renault trucks, Volvo

FLEETGUARD: LF667 / LF16101
HENGST: H200W10
MANN: W11102/36
BALDWIN: 876
DONALDSON: P553191



MJF-001

OE NO.: LF9009
Size: Φ118*294
Thread: 2 1/4-12
Application: Freightliner, International, Ford, Peterbilt, Kenworth, Mack; Cummins Engines

FLEETGUARD: LF9009
HENGST: H300W07
MANN: WP12121
BALDWIN: 8D7309
DONALDSON: P553000



MJF-012

OE NO.: P559000
Size: Φ119*299
Thread: M95 x 2.5
Application: FREIGHTLINER Trucks & Buses

FLEETGUARD: LF9001/LF9080/LF14000NN
CUMMINS: 3406809
MANN: WP 12 120/1
BALDWIN: 8D7154
DONALDSON: P559000



MCC-008

OE NO.: 3308638
Size: Φ94.5*198
Thread: 1-14
Application: Cummins Engines

FLEETGUARD: FS1212 / FS19683
HENGST: H169WK
MANN: WK 950/16 x
BALDWIN: BF1212
DONALDSON: P558000



MJF-074

OE NO.: LF14000NN
Size: Φ120*295
Thread: M95 x 2.5
Application: Freightliner, International, Peterbilt, Kenworth; Cummins Engine

FLEETGUARD: LF14000NN
HENGST:
MANN:
BALDWIN: 8D50000
DONALDSON: P559000



MJC-069

OE NO.: LF3970
Size: Φ93*174
Thread: 1 1/8-16
Application: Freightliner, International, Peterbilt, Kenworth, Mack, Cummins

FLEETGUARD: LF3970
HENGST:
MANN: W951
BALDWIN: 87177
DONALDSON: P550428



MHF-029

OE NO.: LF16046
Size: Φ121*248
Thread:
Application: Freightliner, Sterling, Western Star Trucks; Mercedes-Benz Engines

FLEETGUARD: LF16046
HENGST: E175H D129
MANN: HU 12 110 x
BALDWIN: P7230
DONALDSON: P550769



MHF-079

OE NO.: R61709
Size: Φ109*183.5
Thread:
Application: Detroit Diesel, Freightliner; Western Star, Daimler, Van Hool

FLEETGUARD: FS20176
CUMMINS:
MANN:
BALDWIN:
DONALDSON:



MHG-004

OE NO.: A0000903651
Size: Φ148*193
Thread:
Application: Freightliner Cascadia, Columbia, Business Class M2 all with Detroit Diesel DD13, DD15 Engines

FLEETGUARD: FS19915
HENGST:
MANN:
BALDWIN: PF9804
DONALDSON: P551011



MHD-037

OE NO.: FS19727
Size: Φ97*172
Thread:
Application: Davco FH230 Series, 233 Series, FH233 Series, 382 Series Housings; Freightliner, International, Peterbilt

FLEETGUARD: FS19727/ FS19624/ FS19761
HENGST:
MANN:
BALDWIN: PF7895 / PF7748 / PF7894
DONALDSON: P550467 / P551052



MHF-076

OE NO.: A4711800209
Size: Φ116*277
Thread:
Application: Freightliner, Western Star

FLEETGUARD: LF17800
HENGST:
MANN:
BALDWIN:
DONALDSON:



MHF-067

OE NO.: A4721800509
Size: Φ121*263
Thread:
Application: Freightliner, Western Star; Detroit Diesel DD13, DD15 or DD16 Engines

FLEETGUARD: LF17511
HENGST: E510H07 D254
MANN: HU 12 001 z
BALDWIN: P7505
DONALDSON: P551005



MHG-029

OE NO.: A0000905051
Size: Φ152*192
Thread:
Application: Freightliner, Western Star

FLEETGUARD: FS20083
CUMMINS:
MANN:
BALDWIN: PF46145
DONALDSON:



MHE-023

OE NO.: FS19764
Size: Φ107*172
Thread:
Application: Davco FH230 Series Fuel Pro, FH234 Series Industrial Pro; Freightliner, IHC, Kenworth, Peterbilt

FLEETGUARD: FS19764 / FS19765
HENGST:
MANN:
BALDWIN: PF7930 / PF9814
DONALDSON: P550851 / P550849



WG-375

OE NO.: A0001421089
Size: Φ75*102
Thread:
Application: Freightliner, International, Peterbilt, Kenworth, Mack

FLEETGUARD: UF106
HENGST:
MANN: U58/9 KIT
BALDWIN: PE17002 KIT
DONALDSON:



SETS-008

OE NO.: A0000904251
Size: Φ106.4*237.3
Thread:
Application: Detroit Diesel DD13 12.8L, DD15 14.8L, DD16 15.6L Engines

FLEETGUARD: FK48556
HENGST:
MANN: PU 11 005-3 z
BALDWIN: PF9924 KIT
DONALDSON: P550954



MHF-046

OE NO.: A4700903151
Size:
Thread:
Application: Freightliner, Western Star Trucks with Detroit Diesel DD13, DD15, DD16 Engines

FLEETGUARD: FK13850NN
HENGST: E112KP D276-2
MANN:
BALDWIN: PF9908KIT
DONALDSON: P551063



MHF-077

OE NO.: A4720921705
Size:
Thread:
Application: Freightliner, Western Star, Daimler

FLEETGUARD: FK11011
HENGST:
MANN:
BALDWIN:
DONALDSON:



MCF-021

OE NO.: FF5776
Size: Φ118*224
Thread: M90x2
Application: Freightliner, International, Kenworth, Peterbilt; Cummins Engines

FLEETGUARD: FF5776
HENGST:
MANN: WK12003
BALDWIN: BF9885
DONALDSON: P555776



MCF-010

OE NO.: FS1040
Size: Φ115*292
Thread: M85*2
Application: Cummins Signature 600 Engines; Freightliner, International, Peterbilt, Kenworth, Navistar, Temsa Bus

FLEETGUARD: FS1007 / FS1040
HENGST:
MANN: WK1270
BALDWIN: BF1274-SP
DONALDSON: P551047



MCB-056

OE NO.: FS1251
Size: Φ81*148
Thread: M16 X 1.5
Application: FREIGHTLINER, DAF, KENWORTH

FLEETGUARD: FS1251
HENGST: H179WK
MANN: WK716/2X
BALDWIN: BF1226
DONALDSON: P550248



MCC-006

OE NO.: FS1280
Size: Φ94*159
Thread: 13/16-18
Application: Cummins Engines, IVECO, FREIGHTLINER, NEW HOLLAND, KENWORTH, INTERNATIONAL

FLEETGUARD: FS1280
HENGST: H17WK06
MANN: WK9165X
BALDWIN: BF1280
DONALDSON: P551329



MCF-022

OE NO.: FF5971 NN
Size: Φ118*297
Thread: M90 x 2
Application: Freightliner, International, Peterbilt, Kenworth; Cummins Engines

FLEETGUARD: FF5686 / FF5971 NN
HENGST:
MANN: WK12020
BALDWIN: BF9886
DONALDSON: P555686



MCC-185

OE NO.: FF5632
Size: Φ93*174
Thread: M20x1.5
Application: Ford, Freightliner, Kenworth, Peterbilt, Sterling Trucks; Cummins T5B Engine

FLEETGUARD: FF5632
HENGST:
MANN: WK9037 x
BALDWIN: BF7940
DONALDSON: P550880



MJC-013

OE NO.: 5083285AA
Size: Φ93*174
Thread: 1-16 UN
Application: Freightliner, Peterbilt, Ram, Dodge Light-Duty Trucks

FLEETGUARD: LF3972/LF3349
HENGST:
MANN:
BALDWIN: BT7349
DONALDSON: P558615



MSC-005

OE NO.: WF2071
Size: Φ95*102.5
Thread: 11/16"-16
Application: Freightliner, International, Peterbilt, Kenworth, Case IH, E.R.F.

FLEETGUARD: WF2071 / WF2051
HENGST: H13WF12
MANN: WA9110
BALDWIN: BW5072
DONALDSON: P554071



MHC-023

OE NO.: FF5380
Size: Φ92*103
Thread: M92
Application: Freightliner, Mercedes-Benz

FLEETGUARD: FF5380
HENGST: E52KPD36
MANN: PU1046/1X
BALDWIN: PF7735
DONALDSON: P550632



MCE-091

OE NO.: FS19593
Size: Φ111*158
Thread: 1-14
Application: Freightliner, International, Blue Bird, Western Star

FLEETGUARD: FS19593
HENGST:
MANN:
BALDWIN:
DONALDSON: P553226



MJF-034

OE NO.: C-6001
Size: Φ118*206
Thread: 1 1/2-12
Application: Freightliner, Isuzu

FLEETGUARD: LF734
HENGST: H216W
MANN: W12205
BALDWIN: B205
DONALDSON: P551381



MJC-092

OE NO.: LF3342
Size: Φ94*137
Thread: 1 1/8-16
Application: Freightliner, VOLVO

FLEETGUARD: LF3342
HENGST: H17W21
MANN: W929/3
BALDWIN: BT230
DONALDSON: P555570



MCE-185

OE NO.: FS19521
Size: Φ110*128
Thread: 1-14
Application: Freightliner, Hino, Peterbilt Trucks; Blue Bird Buses; Racor 325 Series

FLEETGUARD: FS19521
HENGST:
MANN:
BALDWIN: BF1348
DONALDSON:



MJF-021

OE NO.: LF9070
Size: Φ118*297
Thread: M95 x 2.5
Application: Freightliner, International, Peterbilt, Kenworth, Western Star, Temsa Bus

FLEETGUARD: LF9070 / LF9000
HENGST:
MANN: WP12001
BALDWIN: BD7153
DONALDSON: P550949



MCC-039

OE NO.: FF5207
Size: Φ93.5*201
Thread: 1-12
Application: FREIGHTLINER, Ford

FLEETGUARD: FF5207
HENGST: H185WK
MANN: WK962/11
BALDWIN: BF5800
DONALDSON: P556915



MCD-007

OE NO.: FF63009
Size: Φ101.5*197
Thread:
Application: Freightliner, International, Peterbilt, Kenworth, Mack, Cummins Engines

FLEETGUARD: FF63009 / FF63054NN
HENGST:
MANN:
BALDWIN:
DONALDSON: P553009



MCC-157

OE NO.: FF5421
Size: Φ94*183
Thread: M20 x 1.5
Application: Freightliner S2 Bus Chassis; Kawasaki 70ZV Loader; Kenworth Trucks

FLEETGUARD: FF5421
HENGST:
MANN: WK929
BALDWIN: BF7966
DONALDSON: P550881



MCC-043

OE NO.: FS1067
Size: Φ94.5*250
Thread: 1"-14
Application: Freightliner, International, Kenworth, Peterbilt, Mack

FLEETGUARD: FS1067/FS1003
HENGST:
MANN: WK10017x
BALDWIN: BF1293-SPS
DONALDSON: P551003



MJF-035

OE NO.: B96
Size: Φ119*285
Thread: 1 1/2-12
Application: Cummins Engines

FLEETGUARD: LF670
HENGST: H240W
MANN: W1294
BALDWIN: B96
DONALDSON: P551670



MSC-014

OE NO.: WF2127
Size: Φ93.5*147
Thread: M36*2
Application: Cummins Engines

FLEETGUARD: WF2127
HENGST:
MANN:
BALDWIN: B5087
DONALDSON: P550867



MCC-045

OE NO.: FF5488
Size: 94*181
Thread: 7/8-14 UN
Application: Freightliner, Caterpillar Engines

FLEETGUARD: FF5321 / FF5488
HENGST: H178WK
MANN: WK850/3
BALDWIN: BF7632
DONALDSON: P551315



MCB-021

OE NO.: FF5327
Size: Φ86*112
Thread: 86*112
Application: FREIGHTLINER

FLEETGUARD: FF5327
HENGST:
MANN:
BALDWIN: BF9842
DONALDSON:



MHU-003

OE NO.: 2122909
Size: Φ
Thread:
Application: Freightliner, Kenworth

FLEETGUARD: UF106
HENGST:
MANN:
BALDWIN: PE17002 KIT
DONALDSON:



MHF-014

OE NO.: 2040PM
Size: Φ110.5*Φ16.8*124
Thread:
Application: Freightliner

FLEETGUARD: FS20403
HENGST: E7040KP30
MANN:
BALDWIN: PF7930 / PF9814
DONALDSON: P550851 / P550849



MHG-031

OE NO.: FS53014
Size: Φ148*414
Thread:
Application: Cummins QSK 19, QSK 23, QSK 38, QSK 50, QSK 60, QST30 Eng.

FLEETGUARD: FS53014
HENGST:
MANN:
BALDWIN: PF46079
DONALDSON: P553014



MCC-274

OE NO.: FS19513
Size: Φ93.5*242
Thread: 1"-12UNF-28
Application: Freightliner, International, Western Star

FLEETGUARD: FS19513
HENGST:
MANN:
BALDWIN: BF1213
DONALDSON: P558010



MGZ-035

OE NO.: NG5900
Size: Φ93.7*182.6
Thread: 1 1/2 -16
Application: Cummins Natural Gas Engines

FLEETGUARD: NG5900
HENGST:
MANN:
BALDWIN: BF7695
DONALDSON: BF7695



MCC-035

OE NO.: 1R-0750
Size: Φ85.6*181
Thread: 1"-14UNS
Application: CAT 3304, 3306, 3406, 3114, 3116 engine

FLEETGUARD: FF5320
HENGST: H172WK
MANN: WDK 950/1
BALDWIN: BF7633
DONALDSON: P551313



MCC-050

OE NO.: 1R-0740
Size: Φ93*170
Thread: 1"-14UNS
Application: Caterpillar, Kenworth, Ford

FLEETGUARD: FF5245
HENGST: H19WK01
MANN: WK 950/3
BALDWIN: BF7525
DONALDSON:



MCC-037

OE NO.: 1R-0749
Size: Φ93*232.7
Thread: 1"X14UNS
Application: Caterpillar, Ford, Freightliner, International, Kenworth, Peterbilt, Sterling, Western Star Trucks

FLEETGUARD: FF5319
HENGST: H175WK
MANN: WK 980/1
BALDWIN: BF7587
DONALDSON: P551311



MCC-036

OE NO.: 1R-0762
Size: Φ93.5*266
Thread: 1"-14UNS-2
Application: Caterpillar Engines, Equipment, Trucks

FLEETGUARD: FF5624
HENGST: H264WK
MANN:
BALDWIN: BF7753
DONALDSON: P550625



MJF-007

OE NO.: 1W-8845
Size: Φ120*254
Thread: 1-3/8"-16
Application: FODEN TRUCKS, RENAULT TRUCKS

FLEETGUARD: LF777
HENGST: H240W01
MANN: WP1290
BALDWIN: 87575
DONALDSON: P550777



MJG-001

OE NO.: 1R-1808/1R-0716
Size: Φ139*306
Thread: 1 1/2-16
Application: Caterpillar

FLEETGUARD: LF691A
HENGST: H300WD01
MANN: W013145
BALDWIN: B99
DONALDSON: P554005



MCC-034

OE NO.: 1R-0751
Size: Φ85.6*181
Thread: 7/8-14
Application: Caterpillar Engines, Equipment

FLEETGUARD: FF5321
HENGST: H178WK
MANN: WK 850/3
BALDWIN: BF7632
DONALDSON: P550879



MCE-053

OE NO.: 326-1644
Size: Φ107.5*181
Thread: 1"-14UNF-28
Application: Caterpillar Equipment

FLEETGUARD: FS20007
HENGST:
MANN:
BALDWIN: BF1399-SP
DONALDSON:



MCE-030

OE NO.: 1R-0770
Size: Φ108*195
Thread: 1"-14
Application: CATERPILLAR Compactors, Dozers

FLEETGUARD: FS19820
HENGST:
MANN:
BALDWIN: BF12845P
DONALDSON: P550626



MCE-106

OE NO.: 326-1643
Size: Φ108*226
Thread: 1"-14
Application: Caterpillar Equipment

FLEETGUARD: FS20007
HENGST:
MANN: XWK1-8259
BALDWIN: BF1397-SP
DONALDSON:

CATERPILLAR



OE NO.: 361-9554
Size: $\Phi 84.5 \times 196.5$
Thread:
Application: Caterpillar Equipment

FLEETGUARD: FS20049
HENGST:
MANN: WK 8184
BALDWIN:
DONALDSON:

MCB-228



OE NO.: 156-1200
Size: $\Phi 84.5 \times 196.5$
Thread:
Application: Caterpillar Equipment

FLEETGUARD: FS19860
HENGST: H202WK 01 D200
MANN: WK 8126
BALDWIN:
DONALDSON:

MCB-246



OE NO.: LF691A
Size: $\Phi 139 \times 304$
Thread: 1.1/2-16
Application: Atlas Copco, Demag, Caterpillar Equipment

FLEETGUARD: LF691A
HENGST: H300WD01
MANN: WD13145
BALDWIN: B99
DONALDSON: P554005

MJG-016



OE NO.: FF185
Size: $\Phi 95 \times 176$
Thread: 1"-14UNF
Application: Caterpillar, International, Link-Belt, New Holland Equipment

FLEETGUARD: FF185
HENGST: H19WK 01
MANN: WK 950/3
BALDWIN: BF970
DONALDSON: P557440

MCC-012



OE NO.: 117-4089
Size: $\Phi 83 \times 150$
Thread:
Application: Caterpillar, John Deere Equipment

FLEETGUARD: FS19858
HENGST: H204WK
MANN: WK 8109
BALDWIN: BF7679-D
DONALDSON: P771723

MCB-051



OE NO.: 138-3100
Size: $\Phi 83 \times 135$
Thread: 3/8-16 UNF
Application: Caterpillar, Perkins Engines; New Holland Tractors

FLEETGUARD: FS19530/FS19811
HENGST: H183WK
MANN: WK 8122
BALDWIN: BF7681-D
DONALDSON: P550399

MCB-015



OE NO.: 326-1641
Size: $\Phi 107.5 \times 240$
Thread: 1"-14UNS-28
Application: Caterpillar Equipment

FLEETGUARD: FS20051
HENGST:
MANN:
BALDWIN:
DONALDSON:

MCE-214



OE NO.: 3608959
Size: Φ
Thread:
Application: Caterpillar Equipment

FLEETGUARD:
HENGST:
MANN:
BALDWIN:
DONALDSON:

MHA-066



OE NO.: 159-6102
Size: $\Phi 83 \times 151$
Thread: 3/8-16 UNF
Application: Caterpillar, Perkins Engines; John Deere Equipment

FLEETGUARD: FS19832
HENGST: H174WK
MANN: WK 8121
BALDWIN: BF7674-D
DONALDSON: P550401

MCB-014



OE NO.: 228-9130
Size: $\Phi 83 \times 194$
Thread:
Application: Case, Caterpillar, New Holland Equipment

FLEETGUARD: FS19837
HENGST: H277WK
MANN: WK 8148
BALDWIN: BF7746-D
DONALDSON: P551433

MCB-073



OE NO.: 1R-0726
Size: $\Phi 186.5 \times \Phi 67 \times 258$
Thread:
Application: Caterpillar Industrial Marine Engines

FLEETGUARD: LF3485
HENGST:
MANN:
BALDWIN: P7003
DONALDSON: P557500

MHG-007



OE NO.: E831HD275
Size: $\Phi 120 \times 177$
Thread:
Application: Caterpillar, IHC Trucks with MaxxForce 11, MaxxForce 13 Engines

FLEETGUARD: LF17519 / LF17549
HENGST: E831HD275
MANN: HU1291/1z
BALDWIN: P7494
DONALDSON: P551088

MHF-057



OE NO.: 541-6956
Size: Φ
Thread:
Application: Caterpillar Equipment

FLEETGUARD:
HENGST:
MANN:
BALDWIN:
DONALDSON:

MCD-010



OE NO.: 438-5386
Size: $\Phi 138.5 \times 327$
Thread: 1-1/4"-12
Application: Caterpillar

FLEETGUARD: FS20131
HENGST:
MANN:
BALDWIN:
DONALDSON: P501108

MCG-003



OE NO.: 2020PM
Size: $\Phi 110.5 \times 242$
Thread:
Application: Racor 1000FH Series Housings; Caterpillar, PETERBILT Trucks

FLEETGUARD: FS20201
HENGST:
MANN:
BALDWIN: PF7890
DONALDSON: P552023

MHF-004



OE NO.: 2010pm
Size: $\Phi 90 \times 75$
Thread:
Application: CATERPILLAR, VOLVO

Caterpillar: 3I-1251
FLEETGUARD: FS19575/FS20103
MANN:
BALDWIN: PF59830
DONALDSON: P552014

MHC-019



OE NO.: 3113901
Size: Φ
Thread:
Application: Caterpillar Equipment

FLEETGUARD:
HENGST:
MANN:
BALDWIN:
DONALDSON:

MHA-065



OE NO.: 1R-0756
Size: $\Phi 100 \times 234$
Thread:
Application: CATERPILLAR ENGINE

FLEETGUARD: FF5323
HENGST: E75KP
MANN:
BALDWIN: PF7655
DONALDSON: P551317

MHE-003



OE NO.: 363-5819
Size: $\Phi 80.5 \times \Phi 26.7 \times 139$
Thread:
Application: Caterpillar Equipment

FLEETGUARD: FS20289
HENGST:
MANN:
BALDWIN:
DONALDSON:

MHB-026



OE NO.: FF5369W
Size: $\Phi 94 \times 179$
Thread:
Application: Caterpillar, Cummins, Detroit Diesel, Mack Engines with Davco Housing

FLEETGUARD: FF5369W / FS1029W
HENGST:
MANN:
BALDWIN: PF7748 / PF7744
DONALDSON: P550463 / P550757

MHD-003



OE NO.: 1R-1804
Size: $\Phi 76 \times \Phi 35 \times 158$
Thread:
Application: Caterpillar Equipment

FLEETGUARD:
HENGST:
MANN:
BALDWIN:
DONALDSON:

MHB-024



OE NO.: 3223155
Size: $\Phi 102 \times 220$
Thread:
Application: Caterpillar Equipment

FLEETGUARD:
HENGST:
MANN:
BALDWIN:
DONALDSON: J8613155

MHB-029



OE NO.: FF5322
Size: $\Phi 93.6 \times 268$
Thread: 7/8"-14
Application: CATERPILLAR

FLEETGUARD: FF5322
CATERPILLAR: 1R-0753
MANN: WK 970/2
BALDWIN: BF7631
DONALDSON: P551312

MCC-275



OE NO.: FF211
Size: $\Phi 110 \times 264$
Thread: 1"-14
Application: Caterpillar Paving Equipment

FLEETGUARD: FF211
HENGST: H170WK
MANN: WK 11102/5
BALDWIN: BF584
DONALDSON: P555823

MCE-038



MJE-035

OE NO.: 1R-0739
Size: $\Phi 108 \times 262$
Thread: 1.1/8-16
Application: Caterpillar Engines, Equipment

FLEETGUARD: LF667 / LF3973
HENGST:
MANN:
BALDWIN: 87600
DONALDSON: P554004 / P551807



MJE-073

OE NO.: 1R-0714
Size: $\Phi 107 \times 147$
Thread: 1 1/8-16
Application: Caterpillar, Iveco, JCB, New Holland, Caterpillar, Isuzu Engines; Chevrolet, GMC, Isuzu, Iveco, Mitsubishi

FLEETGUARD: LF3328
CUMMINS: H211W
MANN: W 1150/2
BALDWIN: 875
DONALDSON: P559128



MHE-035

OE NO.: 436-7077
Size: $\Phi 118 \times 221$
Thread:
Application: Caterpillar Equipment

FLEETGUARD:
HENGST:
MANN:
BALDWIN:
DONALDSON:



MHD-039

OE NO.: 523-4987
Size: $\Phi 103 \times 259$
Thread: M14x4
Application: Caterpillar Equipment

FLEETGUARD:
HENGST:
MANN:
BALDWIN:
DONALDSON:



MCB-198

OE NO.: FS19526
Size: $\Phi 84.5 \times 158$
Thread:
Application: Caterpillar, John Deere

FLEETGUARD: FS19526
HENGST:
MANN: WK 8109
BALDWIN: BF7681-D
DONALDSON: P551430



MJG-022

OE NO.: 87299
Size: $\Phi 139 \times 304$
Thread: 1-1/2"-16 UN-28
Application: Caterpillar Engines

FLEETGUARD:
HENGST:
MANN: WD13145/18
BALDWIN: 87299
DONALDSON: P551808



MHD-040

OE NO.: 509-5694
Size: $\Phi 103 \times 170$
Thread: M14x4
Application: Caterpillar Equipment

FLEETGUARD:
HENGST:
MANN:
BALDWIN:
DONALDSON:



MHA-054

OE NO.: 479-4131
Size: $\Phi 81 \times 227$
Thread: M14x4
Application: Caterpillar Equipment

FLEETGUARD:
HENGST:
MANN:
BALDWIN:
DONALDSON:



MCC-065

OE NO.: FF183
Size: $\Phi 95 \times 138$
Thread: 15/16"-16
Application: Caterpillar, New Holland

FLEETGUARD: FF183
CATERPILLAR: 1R-0710
MANN:
BALDWIN: BF583
DONALDSON:



MJC-281

OE NO.: 2698325
Size: $\Phi 94.5 \times 206.5$
Thread: M24 \times 1.5-6H
Application: Caterpillar Equipment

FLEETGUARD: LF17475
HENGST:
MANN: W962/50
BALDWIN: 87378
DONALDSON: P550920



MCE-011

OE NO.: R120T
Size: $\Phi 110 \times 216$
Thread: 1-14 UNS
Application: Caterpillar, John Deere, Racor, Parker

FLEETGUARD: FS19591
HENGST: H7120WK30
MANN: WK 11 002 x
BALDWIN: BF1395-O
DONALDSON: P551025



MJE-051

OE NO.: LF3828
Size: $\Phi 110 \times 108$
Thread: 1"-12 UNF-28
Application: Caterpillar Lift Trucks; Mitsubishi Engines

FLEETGUARD: LF3828
HENGST:
MANN: W 1126/10
BALDWIN: 87131
DONALDSON: P502458



MCE-216

OE NO.: BF9903-SP
Size: $\Phi 108 \times 234$
Thread: 1-14 UN
Application: Caterpillar Equipment; Kenworth, Western Star Trucks

FLEETGUARD: FS20051
HENGST:
MANN:
BALDWIN: BF9903-SP
DONALDSON:



MCC-069

OE NO.: FF261
Size: $\Phi 86 \times 147$
Thread: M12 \times 1.5-6H
Application: Caterpillar Equipment

FLEETGUARD: FF261
HENGST:
MANN:
BALDWIN: BF7990
DONALDSON:



MSC-007

OE NO.: 9N3368
Size: $\Phi 94.5 \times 107$
Thread: 1 1/16-16
Application: Caterpillar, International, Komatsu; Chevrolet, Freightliner, GMC, International, Iveco, Kenworth, Peterbilt

FLEETGUARD: WF2051 / WF2071
HENGST: H13WF12
MANN: WA 9110
BALDWIN: 8W5137
DONALDSON: P554071



MCC-048

OE NO.: 3329289
Size: $\Phi 94.5 \times 241$
Thread: 1-14
Application: Caterpillar, Cummins Engines; Euclid Rear Dumps; Kenworth, Volvo Trucks; Versatile Tractors

FLEETGUARD: FS1000
HENGST: H181WK
MANN: WK 965
BALDWIN: BF1259
DONALDSON: P551000



MHD-009

OE NO.: 3F-1233
Size: 126 \times 94 \times 84
Thread:
Application: CATERPILLAR Compactors, Dozers

FLEETGUARD: FF203
HENGST:
MANN: WK 13 001
BALDWIN: BF909
DONALDSON: P551130

MACK



MCE-069

OE NO.: 483GB444
Size: $\Phi 109 \times 202$
Thread: 13/16-18
Application: MACK, Renault Trucks

FLEETGUARD: FF172
HENGST: H200WN01
MANN: WP 11 102/3
BALDWIN: BF877
DONALDSON: P550219



MCE-071

OE NO.: 483GB471M
Size: $\Phi 110 \times 263$
Thread: M30x1.5
Application: MACK Trucks

FLEETGUARD: FF5382
HENGST:
MANN:
BALDWIN: BF7657
DONALDSON: P554471



MCE-067

OE NO.: 483GB440
Size: $\Phi 110 \times 263$
Thread: 1.1/16-16
Application: Mack Trucks

FLEETGUARD: FF222
HENGST:
MANN:
BALDWIN: BF976
DONALDSON: P550431



MJC-188

OE NO.: 8C110
Size: $\Phi 96.5 \times 119$
Thread:
Application: Mack Engines

FLEETGUARD: LF3416
HENGST: Z10 D64
MANN: ZR 902 x
BALDWIN: 8C110
DONALDSON: P550286



MCE-070

OE NO.: 483GB470M
Size: $\Phi 110 \times 202$
Thread: M22*1.5
Application: MACK Trucks

FLEETGUARD: FF5381
HENGST:
MANN:
BALDWIN: BF7656
DONALDSON: P554470



MCE-068

OE NO.: 483GB441
Size: $\Phi 109 \times 202$
Thread: 7/8-16
Application: MACK Trucks, MECO Trucks

FLEETGUARD: FF171
HENGST:
MANN:
BALDWIN: BF876
DONALDSON: P550218



MSC-001

OE NO.: 25MF435B
Size: $\Phi 94.5 \times 148$
Thread: 3/4-20
Application: Mack Engines, Trucks

FLEETGUARD: WF2015
HENGST: H27WF
MANN: WA 940/15
BALDWIN: BW5178
DONALDSON: P554860



MJC-186

OE NO.: CS41010
Size: $\Phi 108 \times 189$
Thread:
Application: Mack Engines

FLEETGUARD: CS41010
HENGST:
MANN:
BALDWIN: BC7228
DONALDSON:



MSE-001

OE NO.: 25MF436B
Size: $\Phi 107 \times 144$
Thread: 1-16UN-2B
Application: MACK Trucks, Engine

FLEETGUARD: WF2022
HENGST:
MANN: WA1144
BALDWIN: BW5177
DONALDSON:



MJE-002

OE NO.: 485G83191C
Size: $\Phi 110 \times 263$
Thread: 1 X 1/8"-16
Application: Mack; Renault trucks, Volvo

FLEETGUARD: LF16101
HENGST: H200W10
MANN: W11102/36
BALDWIN: 876
DONALDSON: P553191



MJC-185

OE NO.: 236GB245M
Size: $\Phi 92 \times 120$
Thread:
Application: Mack, R.M.I. Engines

FLEETGUARD: CS41005
HENGST: Z13D94
MANN: ZR904X
BALDWIN: BC7173
DONALDSON: P550287



MJC-187

OE NO.: 236GB42M
Size: $\Phi 98 \times 188$
Thread: M30x1.5
Application: MACK Trucks

FLEETGUARD: CS41011
HENGST:
MANN:
BALDWIN: 8C7242
DONALDSON: P552231



MJE-091

OE NO.: PH9376
Size: $\Phi 109.5 \times 263$
Thread: 1-1/8"-16UNS-2B
Application: Mack Trucks

FLEETGUARD: LF3973
HENGST:
MANN:
BALDWIN: 87225
DONALDSON: P551807

DAF



MHF-070

OE NO.: 2234788
Size: $\Phi 120 \times 234$
Thread:
Application: DAF - XF106

FLEETGUARD: LF16368
HENGST:
MANN:
BALDWIN:
DONALDSON:



MHF-032

OE NO.: 1397764
Size: $\Phi 113 \times \Phi 56.5 \times 150$
Thread:
Application: DAF Trucks

FLEETGUARD: LF16042
HENGST: E34HD213
MANN: HU1270x
BALDWIN: P7232
DONALDSON: P550630



MHF-054

OE NO.: LF16233
Size: $\Phi 112 \times 220$
Thread:
Application: DAF, Kenworth, Peterbilt Trucks

FLEETGUARD: LF16233
HENGST: E89HD213
MANN: HU12103x
BALDWIN: P40019
DONALDSON: P550812



MHE-001

OE NO.: 1397765
Size: $\Phi 109 \times \Phi 65 \times 220$
Thread:
Application: DAF Buses, Trucks

FLEETGUARD: LF16232
HENGST: E43HD213
MANN: HU1297x
BALDWIN: P7330
DONALDSON: P550661



MHC-024

OE NO.: 1397766
Size: $\Phi 103 \times 202$
Thread:
Application: DAF Trucks

FLEETGUARD: FF5510
HENGST: E66KP36
MANN: PU999/2X
BALDWIN: PF7767
DONALDSON: P550631



MHE-043

OE NO.: 2277129
Size:
Thread:
Application: Peterbilt DAF Kenworth Trucks

FLEETGUARD:
HENGST:
MANN:
BALDWIN:
DONALDSON:



MHE-046

OE NO.: 2277128
Size: $\Phi 100 \times 224$
Thread:
Application: DAF

FLEETGUARD:
CUMMINS:
MANN:
BALDWIN:
DONALDSON:



MHE-025

OE NO.: 2164463
Size: $\Phi 100 \times 284$
Thread:
Application: DAF

FLEETGUARD:
HENGST:
MANN:
BALDWIN:
DONALDSON:



MHC-075

OE NO.: 1616361
Size: $\Phi 95 \times \Phi 46 \times 250$
Thread:
Application: DAF Engines, Trucks

FLEETGUARD: FF5695
HENGST: E82KP36
MANN: PU966/1x
BALDWIN: PF7947
DONALDSON: P550863



MCC-026

OE NO.: FF5485
Size: $\Phi 93 \times 174$
Thread: M20 x 1.5
Application: Cummins Engines; DAF, Iveco Trucks

FLEETGUARD: FF5485
HENGST: H191WK
MANN: WK950/21
BALDWIN: BF7813
DONALDSON: P550881



MCE-012

OE NO.: FS19754
Size: $\Phi 107.4 \times 216.6$
Thread: 1"-14 UNS-2
Application: DAF DB, TEMSASAFIR PLUS

FLEETGUARD: FS19754
HENGST: H7120WK30
MANN: WK11002x
BALDWIN: BF1281
DONALDSON: P550177



MJG-017

OE NO.: 1345332
Size: $\Phi 138 \times 221$
Thread: M42*2
Application: DAF Trucks

FLEETGUARD: LF3843
HENGST: H300W06
MANN: W13110
BALDWIN: B7161
DONALDSON:



MJG-008

OE NO.: LF3747
Size: $\Phi 138 \times 234$
Thread: 1-1/2"-16UNF-2B
Application: DAF Trucks

FLEETGUARD: LF3747
HENGST: H250W
MANN: W13120/2
BALDWIN: 87182
DONALDSON: P550727



MCC-135

OE NO.: FF5366
Size: $\Phi 96 \times 143$
Thread: M22*1.5
Application: DAF Trucks

FLEETGUARD: FF5366
HENGST: H18WDK03
MANN: WDK925
BALDWIN: BF7747
DONALDSON: P550810



MJC-007

OE NO.: 0611049
Size: $\Phi 93 \times 181$
Thread: 1"X12 UNF
Application: DAF, Nissan, VOLVO

FLEETGUARD: LF4154
HENGST: H19W01
MANN: W950
BALDWIN: 8975
DONALDSON: P550362



MJC-067

OE NO.: LF16015
Size: $\Phi 93.5 \times 174$
Thread: M27x2
Application: IVECO, BMW, FORD, DAF

FLEETGUARD: LF16015
HENGST: H19W10
MANN: W950/26
BALDWIN: BT7237
DONALDSON: P550520



MJG-013

OE NO.: 1310901
Size: $\Phi 137 \times 316$
Thread: M42X2
Application: DAF

FLEETGUARD: LF3737
CUMMINS: H300W02
MANN: W13145/6
BALDWIN: 87162
DONALDSON: P550452



MJG-012

OE NO.: 0267714
Size: $\Phi 136 \times 308$
Thread: 1 1/2-16 UN
Application: DAF, NEOPLAN Transliner

FLEETGUARD: LF3493
HENGST: H300W01
MANN: W13145/3
BALDWIN: 8239
DONALDSON: P550341



MCC-004

OE NO.: 247138
Size: $\Phi 95 \times 209$
Thread: M16X1.5 -6H
Application: DAF F 2000, NEOPLAN Transliner

FLEETGUARD: FF4070
CUMMINS: H18WK04
MANN: WK962/4
BALDWIN: BF980
DONALDSON: P559624



MCC-052

OE NO.: 1318695
Size: $\Phi 95 \times 143$
Thread: M16X1.5
Application: DAF, Solaris URBINO, NEOPLAN Transliner

FLEETGUARD: FF5298
HENGST: H17WK03
MANN: WDK940/5
BALDWIN: BF7664
DONALDSON: P550494



MCC-242

OE NO.: FS19584
Size: $\Phi 94 \times 184$
Thread: M20*1.5-6H
Application: Cummins ISBE Engine; DAF Trucks

FLEETGUARD: FS19584
HENGST: H190WK
MANN: WK9047
BALDWIN: BF7941
DONALDSON:



MCC-056

OE NO.: FF5702
Size: $\Phi 94.5 \times 211$
Thread: M16*1.5
Application: DAF, IVECO

FLEETGUARD: FF5702
HENGST:
MANN: WDK962/12
BALDWIN: BF7696
DONALDSON: P550472

FORD



OE NO.: WF2072
Size: $\Phi 94 \times 111$
Thread: 11/16-16
Application: Cummins Engines

FLEETGUARD: WF2072
HENGST: H33WF
MANN: WA923/6
BALDWIN: BW5072
DONALDSON:

MSC-002



OE NO.: B7451
Size: $\Phi 93 \times 130$
Thread: M24 x 2.0
Application: Foton FT404, FTS04, Taishan TS554 Tractors

FLEETGUARD: LF17533
HENGST:
MANN:
BALDWIN: B7451
DONALDSON:

MJC-194



OE NO.: 3C3Z9N1B4CB
Size:
Thread:
Application: Ford Light-Duty Trucks; International Engines

FLEETGUARD: FS19797
HENGST:
MANN:
BALDWIN: PF7812 KIT
DONALDSON: P550527

WG-256



OE NO.: BC3Z-9N184-B
Size:
Thread:
Application: Ford Super Duty Trucks with V8-406 (6.7L) FI Turbo Diesel Engine

FLEETGUARD: FK22004
HENGST:
MANN:
BALDWIN: BF9895 KIT
DONALDSON:

WG-256



OE NO.: BC3Z6731B
Size: $\Phi 94 \times 172$
Thread: 1"-16UN
Application: Ford Super Duty Pickups with V8-406 (6.7L) Turbo Diesel Engine

FLEETGUARD: LF17494
HENGST:
MANN:
BALDWIN: B7379
DONALDSON:

MJC-096



OE NO.: 8C3Z9N184A
Size:
Thread:
Application: Ford Super Duty Pickups with V8-391 (6.4L) DI Turbo Diesel Engine

FLEETGUARD: FK48002
HENGST:
MANN:
BALDWIN: PF7934 KIT
DONALDSON: P550815

SETS-009



OE NO.: FD4625
Size:
Thread:
Application: 2017-2022 Ford F250 F350 F450 F550 Super Duty 6.7L Diesel Engine

FLEETGUARD:
CUMMINS:
MANN:
BALDWIN: PF46174 KIT
DONALDSON:

SETS-007



OE NO.: FL2016SET
Size: $\Phi 83 \times 180$
Thread:
Application: Ford Light-Duty Trucks; International Engines

FLEETGUARD: LF16166
HENGST:
MANN:
BALDWIN: P7235
DONALDSON: P550528

MHC-102-300



OE NO.: FS1240
Size: $\Phi 95 \times 93$
Thread: 1"-14
Application: Ford

FLEETGUARD: FS1240
CUMMINS:
MANN:
BALDWIN:
DONALDSON:

MCC-097



OE NO.: E-158437
Size: $\Phi 95.5 \times 151$
Thread: 1"-14
Application: Ford, John Deere Engines

FLEETGUARD: FS20114
HENGST:
MANN:
BALDWIN: BF1205
DONALDSON: P550844

MCC-267



OE NO.: FF5040
Size: $\Phi 77 \times 88$
Thread: M16 x 1.5
Application: Ford Volvo, Man

FLEETGUARD: FF5040
HENGST: H30WK01
MANN: WK712/2
BALDWIN: BF790
DONALDSON: P550588

MCB-160



OE NO.: DBNN-6714-DA
Size: $\Phi 136.5 \times 153$
Thread: 1 1/8-16
Application: Ford Equipment

FLEETGUARD: LF3360
HENGST: H212W
MANN:
BALDWIN: BT343
DONALDSON: P550157

MJG-020



OE NO.: FF1050
Size: 94*138
Thread: 1"-14
Application: Cummins Engines, Freightliner, International, Ford

FLEETGUARD: FF1050
HENGST:
MANN: WK955/2
BALDWIN: BF957
DONALDSON: P550106

MCC-082



OE NO.: LF16353
Size: 108*227
Thread: M 30 X 2
Application: FORD Cargo

FLEETGUARD: LF16353
HENGST:
MANN: W1170/9
BALDWIN:
DONALDSON:

MJE-087



OE NO.: FF5219
Size: $\Phi 94.5 \times 112$
Thread: M20*1.5-6H
Application: Ford, Mazda

FLEETGUARD: FF5219
HENGST:
MANN:
BALDWIN: BF789
DONALDSON:

MCC-205



OE NO.: FF5021
Size: $\Phi 93 \times 109$
Thread: 13/16-12 UN5-2B
Application: Ford; Detroit Diesel Engines

FLEETGUARD: FF5021
HENGST:
MANN:
BALDWIN: BF593
DONALDSON: P550928

MCC-272



OE NO.: W719/5
Size: $\Phi 78 \times 121$
Thread: 3/4"-16UNF-2B
Application: Ford, Volkswagen, Audi

FLEETGUARD: LF3568
HENGST: H14W04
MANN: W719/5
BALDWIN:
DONALDSON: P554770

MJB-048



OE NO.: LF716
Size: $\Phi 78.5 \times 120$
Thread: M20*1.5-6H
Application: Ford, Mazda

FLEETGUARD: LF716
HENGST: H90W25
MANN:
BALDWIN:
DONALDSON:

MJB-070



OE NO.: C-1809
Size: $\Phi 70 \times 64.5$
Thread: M20x1.5
Application: Ford, Kia, Honda, Mazda, Nissan, Subaru Automotive, Light-Duty Trucks; Kawasaki Motorcycles

FLEETGUARD:
HENGST:
MANN:
BALDWIN: 81400
DONALDSON: P502062

MJA-026



OE NO.: HU711/51X
Size: $\Phi 64 \times 69$
Thread:
Application: Ford, Peugeot, Fiat

FLEETGUARD: LF16448
HENGST: E44H D110
MANN: HU711/51X
BALDWIN:
DONALDSON:

WG-336



OE NO.: L321-14-302
Size: $\Phi 65 \times \Phi 28 \times 71$
Thread:
Application: Ford, Mazda Automotive

FLEETGUARD: LF16423
HENGST:
MANN: HU711/2x
BALDWIN: P7313
DONALDSON:

MHA-013



OE NO.: E-1902
Size: $\Phi 92 \times 58.5$
Thread:
Application: Ford

FLEETGUARD: LF16113
HENGST: E33H D96
MANN: HU920x
BALDWIN:
DONALDSON:

MHD-005



MCB-183

OE NO.: WK8105
Size: Ø83*197
Thread:
Application: Ford

FLEETGUARD: FS19837
HENGST: H203WK
MANN: WK8105
BALDWIN: BF7964-D
DONALDSON: P575722



MCC-273

OE NO.: P502157
Size: Ø94.5*97
Thread: M20*1.5-6H
Application: Ford Light-Duty Trucks;
Gehl, John Deere, Kohler, Thomas,
Westerbeke Equipment

FLEETGUARD:
HENGST:
MANN: WK920/3
BALDWIN: BF789
DONALDSON: P502157



MJC-167

OE NO.: LF4016
Size: Ø96.5*117
Thread: 3/4"-16UNF-2B
Application: Ford

FLEETGUARD: LF4016
HENGST: H24W03
MANN: W930/20
BALDWIN:
DONALDSON: P550008



MCC-016

OE NO.: 23390-YZZA8
Size: Ø93*119
Thread: 3/4"-16UNF-2B
Application: Ford, Toyota

FLEETGUARD:
HENGST:
MANN: WK828x
BALDWIN:
DONALDSON:



WG-049

OE NO.: 6CQ6744AA
Size: Ø65*Ø24.5*68
Thread:
Application: Ford, Peugeot, Citroen

FLEETGUARD:
HENGST: E44HD110
MANN: HU 711 /51 x
BALDWIN:
DONALDSON:



WG-360

OE NO.: G4777
Size: Ø57*125
Thread:
Application: Ford, HOLDEN, Nissan

FLEETGUARD: FF5190
HENGST: H163WK
MANN: WK 66
BALDWIN:
DONALDSON:



WG-361

OE NO.: 2CSZ9155-AA
Size: Ø79*172
Thread: 5/16
Application: Ford, Lincoln, Mercury
Automotive, Light-Duty Trucks

FLEETGUARD: FF260
HENGST:
MANN: WK 78/2
BALDWIN: BF7802
DONALDSON:



MCB-227

OE NO.: P551423
Size: Ø80*135
Thread:
Application: John Deere Engines,
Equipment

FLEETGUARD: FS19516
HENGST: H196WK
MANN: WK8126
BALDWIN: BF7673-D
DONALDSON: P551423



MCB-258

OE NO.: P551424
Size: Ø80*154
Thread:
Application: Caterpillar, Perkins
Engines; John Deere Equipment

FLEETGUARD: FS19839
HENGST: H174WK
MANN: WK8107
BALDWIN: BF7674-D
DONALDSON: P551424



MJC-023

OE NO.: T19044
Size: Ø93*142
Thread: 1 3/16-16
Application: John Deere

FLEETGUARD: LF678
HENGST: H17W09
MANN: W 936/4
BALDWIN: BT259
DONALDSON: P550020



MCB-013

OE NO.: RE60021
Size: Ø84*115
Thread:
Application: JOHN DEERE Series 5

FLEETGUARD: FS19838
HENGST: H202WK
MANN: WK8118
BALDWIN: BF7675-D
DONALDSON:



MJC-084

OE NO.: RES18977
Size: Ø95*138
Thread: M24X1.5
Application: JOHN DEERE Series 4000

FLEETGUARD: LF16173
HENGST:
MANN: W 9032
BALDWIN: P87306
DONALDSON: P550758



MJC-060

OE NO.: RE59754
Size: Ø94*140
Thread: 1 1/2"X16
Application: JOHN DEERE Series 6010

FLEETGUARD: LF3703
HENGST: H26W01
MANN: W 925
BALDWIN: B7125
DONALDSON: P551352



MCB-232

OE NO.: RE522878
Size: Ø84.5*199
Thread:
Application: John Deere Equipment

FLEETGUARD: FS19976
HENGST:
MANN:
BALDWIN: BF7949-D
DONALDSON: P551422



MJC-196

OE NO.: RE504836
Size: Ø94*151
Thread: M92X2.5
Application: John Deere Equipment

FLEETGUARD: LF16243
HENGST:
MANN: W 1022
BALDWIN: 87322
DONALDSON: P550779



MCB-111

OE NO.: FS19861
Size: Ø84*155
Thread:
Application: JOHN DEERE Series

FLEETGUARD: FS19861
HENGST: H174WK
MANN: WK 8102
BALDWIN: BF7672-D
DONALDSON:



MCE-244 MHD-058

OE NO.: RE525523
Size: Ø110*166.5 / Ø95*157
Thread: 1"-14UNS-2B
Application: John Deere Equipment

FLEETGUARD: FK48001
HENGST:
MANN: SP 30082 x
BALDWIN: BF7929 KT
DONALDSON: P551124

JOHN DEERE



OE NO.: BF7904-D
Size: $\Phi 84.5 \times 159$
Thread:
Application: John Deere Engines, Equipment

FLEETGUARD: FS19912
HENGST:
MANN: WK B133
BALDWIN: BF7904-D
DONALDSON:

MCB-186



OE NO.: RE529643
Size: $\Phi 89 \times 195$
Thread:
Application: John Deere Equipment

FLEETGUARD:
HENGST:
MANN:
BALDWIN:
DONALDSON:

MCB-185



OE NO.: F519812
Size: $\Phi 84.5 \times 199$
Thread:
Application: John Deere

FLEETGUARD: FS19812
HENGST: H302WK
MANN: WK8117
BALDWIN:
DONALDSON:

MCB-179



OE NO.: RE62418
Size: $\Phi 84 \times 140$
Thread:
Application: John Deere Engines, Equipment

FLEETGUARD:
HENGST: H196WK
MANN: WK8100
BALDWIN: BF7673-D
DONALDSON: P550351

MCB-135



OE NO.: 201-55370
Size: $\Phi 78 \times 88$
Thread: 3/4"-16UNF-2B
Application: BMW, Dodge, GMC, Toyota Automotive; Bobcat, Cub Cadet, Interceptor, John Deere Equipment

FLEETGUARD:
HENGST: H90W20
MANN: W712/21
BALDWIN: BT223
DONALDSON:

MJB-021



OE NO.: F519830
Size: $\Phi 85 \times 157$
Thread:
Application: John Deere Equipment

FLEETGUARD: FS19830
HENGST:
MANN: WK8135
BALDWIN: BF7784-D
DONALDSON:

MCB-213



OE NO.: WF2077
Size: $\Phi 94.5 \times 137$
Thread: 1 1/16"-16UN-2B
Application: John Deere Equipment

FLEETGUARD: WF2077
HENGST: H35WF
MANN: WA 940/18
BALDWIN: B5134
DONALDSON: P554685

MSC-010



OE NO.: AL169059
Size: $\Phi 108 \times 292$
Thread:
Application: John Deere 6090, 6125, 6430, 6830

FLEETGUARD:
HENGST:
MANN:
BALDWIN:
DONALDSON:

MHD-032



OE NO.: TY15193
Size: $\Phi 75 \times 133$
Thread:
Application: B10-AL, B10-AL BSP Assembly

FLEETGUARD: FF246
HENGST:
MANN:
BALDWIN: PF10
DONALDSON: P550674

MHB-023



OE NO.: F519580
Size: $\Phi 93 \times 126.5$
Thread: M22 x 1.5
Application: Thermo King Refrigeration Units

FLEETGUARD: FS19580
HENGST:
MANN:
BALDWIN: BF9894
DONALDSON: P550834

MCC-122



OE NO.: 11-9957
Size: Φ
Thread:
Application: Thermo King

FLEETGUARD:
HENGST:
MANN:
BALDWIN:
DONALDSON:

WG-291



OE NO.: 11-7382
Size: $\Phi 95 \times 173$
Thread: M26 x 1.5
Application: Thermo King Refrigeration Units

FLEETGUARD: LF3746
HENGST: H19W09
MANN:
BALDWIN: 8D7095
DONALDSON: P557382

MJC-063



OE NO.: 11-9182
Size: $\Phi 94.4 \times 181$
Thread: 1-1/8"-12
Application: Thermo King Refrigeration Units

FLEETGUARD: LF9030
HENGST:
MANN:
BALDWIN: 87375
DONALDSON: P550835

MJC-173



OE NO.: LF4017
Size: $\Phi 95 \times 173$
Thread: 1"-12UNF
Application: Thermo King Refrigeration Units; Akerman Broyt Equipment; Volvo Buses, Equipment, Trucks

FLEETGUARD: LF4017
HENGST: H19W05
MANN: W950/13
BALDWIN: 8975
DONALDSON: P558250

MJC-132



OE NO.: LF694
Size: $\Phi 95.5 \times 178$
Thread: 1"-12
Application: Case, Hydra-Mac, Perkins Engines, Equipment; Thermo King Refrigeration Units

FLEETGUARD: LF694
HENGST:
MANN: W954
BALDWIN: BT365
DONALDSON:

MJC-172



OE NO.: FF204
Size: $\Phi 95 \times 137$
Thread: 7/8"-14
Application: Thermo King Refrigeration Units

FLEETGUARD: FF204
HENGST: H194WK
MANN:
BALDWIN: BF992
DONALDSON: P553693

MCC-201



OE NO.: FF5017
Size: $\Phi 95.5 \times 178$
Thread: 1"-14UNS
Application: Thermo King Refrigeration Units

FLEETGUARD: FF5017
HENGST:
MANN: WK 952/3
BALDWIN: BF991
DONALDSON:

MCC-123



OE NO.: LF16354
Size: $\Phi 84 \times 103$
Thread: M 20 X 1.5
Application: Thermo King Refrigeration Units

FLEETGUARD: LF16354
CUMMINS:
MANN: W 87
BALDWIN: 8161-S
DONALDSON:

MJB-145



OE NO.: LF17519
Size: $\Phi 93 \times 136$
Thread: 3/4-20 UN
Application: Thermo King Refrigeration Units

FLEETGUARD: LF3641
HENGST: H95W01
MANN: W 933/5
BALDWIN:
DONALDSON: P552363

MJC-270

THERMO KING & CARRIER



MJC-305

OE NO.: 11-9959
Size: $\Phi 93.7 \times 136.5$
Thread: M87*3-6H
Application: Thermo King

FLEETGUARD:
HENGST:
MANN:
BALDWIN:
DONALDSON:



MJE-114

OE NO.: LF702
Size: $\Phi 111 \times 177$
Thread: 1"-12UNF-2B
Application: Thermo King

FLEETGUARD: LF702
HENGST:
MANN: W 1168/5
BALDWIN: B129
DONALDSON: P553871



MJC-271

OE NO.: 30-0030400
Size: $\Phi 94.5 \times 172$
Thread: 5/8"-18UNF-2B
Application: Thermo King, Carrier Refrigeration Units

FLEETGUARD: LF778
HENGST:
MANN:
BALDWIN: B164
DONALDSON: P553404



MCE-143

OE NO.: FF5301
Size: $\Phi 108 \times 147$
Thread: 1"-14UNS-2B
Application: Hino, Carrier-Transcold Refrigeration Units

FLEETGUARD: FF5301
HENGST:
MANN:
BALDWIN: BF1224
DONALDSON: P559125



MJC-261

OE NO.: LF9028
Size: $\Phi 93 \times 174$
Thread: 1-16
Application: Carrier Refrigeration Units

FLEETGUARD: LF9028
HENGST:
MANN:
BALDWIN: BD7317
DONALDSON: DBL7349

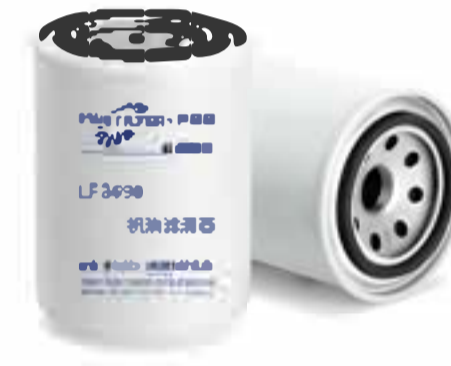

MJB-134

OE NO.: LF3490
Size: $\Phi 84 \times 114$
Thread: 3/4-16 UNF-2B
Application: Carrier-Transcold Refrigeration Units

FLEETGUARD: LF3490
HENGST: H14/2W
MANN: W 719/4
BALDWIN: B7139
DONALDSON: P550715

EUROPEAN SERIES

VOLVO



MJE-006

OE NO.: 477556
Size: $\Phi 110 \times 263$
Thread: 1.3/8-16
Application: VOLVO, RENAULT, MACK

FLEETGUARD: LF3654
HENGST: H200WN01
MANN: WP1102
BALDWIN: B7685
DONALDSON: P550425



MCE-009

OE NO.: 20430751
Size: $\Phi 110 \times 263$
Thread: M32X1.5
Application: Mack Engines, Trucks; R.V.I. Trucks; Volvo Buses, Engines, Trucks

FLEETGUARD: FF5507
HENGST: H200WDK
MANN: W0K11102/9
BALDWIN: BF7814
DONALDSON: P550529



MJE-005

OE NO.: 466634
Size: $\Phi 108 \times 262$
Thread: 1 1/8-16 UN
Application: Volvo

FLEETGUARD: LF3321
HENGST: H200W01
MANN: W11102/36
BALDWIN:
DONALDSON: P554004



MSC-006

OE NO.: WF2108
Size: $\Phi 93 \times 136$
Thread: M16 x 1.5
Application: Volvo - VNL SERIES

FLEETGUARD: WF2108 / WF2096
HENGST:
MANN: WA 940/12
BALDWIN:
DONALDSON: P554019



MCE-013

OE NO.: R90P
Size: $\Phi 110 \times 157$
Thread: 1-14
Application: Volvo Trucks

FLEETGUARD: F519551 / F519532
HENGST: H7090WK10
MANN: WK 1060/5 x
BALDWIN: BF1390-0
DONALDSON: P551066



MCB-029

OE NO.: FF5052
Size: $\Phi 77 \times 120$
Thread: M16 x 1.5
Application: Deutz, Volvo Engines; R.V.I. Trucks

FLEETGUARD: FF5052 / FF5018
HENGST: H60WK01
MANN: WK 723/6
BALDWIN: BF988
DONALDSON: P553004



MJE-098

OE NO.: LF3675
Size: $\Phi 110 \times 263$
Thread: 1 1/8"16UNF-2B
Application: RENAULT TRUCKS; VOLVO

FLEETGUARD: LF3675
HENGST: H200W04
MANN: W1110234
BALDWIN: B-7600
DONALDSON: P167404



MHD-037

OE NO.: 84273566
Size: $\Phi 96.5 \times 180$
Thread:
Application: Cummins ISX Engines; Davco Fuel Pro FH230 Series, 382 Series Housings; Kenworth, Mack, Volvo

FLEETGUARD: FS19728
HENGST:
MANN:
BALDWIN: PF7782
DONALDSON: P550736



MCE-221

OE NO.: 21380488
Size: $\Phi 112 \times 160$
Thread: 1"-14
Application: Volvo Engines, Trucks

FLEETGUARD: FS19920
HENGST: H328WK
MANN: WK11001x
BALDWIN: BF1387-0
DONALDSON: P551066



MCC-013

OE NO.: 20514654
Size: $\Phi 95.5 \times 142$
Thread: 1"-14
Application: RENAULT TRUCKSPremium 2; VOLVO FH 16

FLEETGUARD: FS19735
HENGST: H328WK
MANN: WK 940/33 x
BALDWIN: BF13660
DONALDSON:



MJC-079

OE NO.: 6612598
Size: $\Phi 93 \times 181$
Thread: 3/4"-16UNF
Application: VOLVO, RENAULT, Nissan

FLEETGUARD: LF699
HENGST: H17W02
MANN: W 940/1
BALDWIN:
DONALDSON: P550299



MCE-022

OE NO.: 20879812
Size: $\Phi 108 \times 164$
Thread: 1" x14
Application: RENAULT Trucks; Volvo FH

FLEETGUARD: FS19920
HENGST: H7091WK30 D199
MANN: WK 11 001 x
BALDWIN: BF13870
DONALDSON: P551066



MCB-071

OE NO.: 12705299
Size: $\Phi 84 \times 184.5$
Thread: M16X1.56H
Application: VOLVO, Volkswagen

FLEETGUARD:
HENGST: H119WK
MANN: WK845/1
BALDWIN:
DONALDSON:



MJE-096

OE NO.: LF682
Size: $\Phi 108 \times 148$
Thread: 3/4 - 16
Application: VOLVO, IVECO

FLEETGUARD: LF682
HENGST: H208W01
MANN: W1140
BALDWIN: BT348
DONALDSON: P553411



MCB-032

OE NO.: 466987-5
Size: $\Phi 78.5 \times 124$
Thread: M16X1.5
Application: Volvo FH 16, RENAULT TRUCKS, IVECO, DAF, SCANIA

FLEETGUARD: FFS074
HENGST: H60WK07
MANN: WK 723/6
BALDWIN: BF988
DONALDSON: P553004



MCE-028

OE NO.: 20853583
Size: $\Phi 127.4 \times 104.5$
Thread: 1"-14UNS-2
Application: RENAULT TRUCKS Premium 2, VOLVO FE

FLEETGUARD: FS19895
HENGST: H7062WK30
MANN: WK 1040/1 x
BALDWIN: BF13880
DONALDSON: P551033



MHC-106

OE NO.: 5222677134
Size: $\Phi 86 \times 127$
Thread:
Application: Volvo, NISSAN

REFERENCE NO.: 22296415
HENGST:
MANN:
BALDWIN:
DONALDSON:



MCE-023

OE NO.: FF254
Size: $\Phi 110 \times 263$
Thread: M32X1.5
Application: Mack, Volvo Trucks

FLEETGUARD: FF254
HENGST: H200WDK01
MANN: WDK11102/11
BALDWIN: BF7814
DONALDSON: P550529



MCA-002

OE NO.: 466987
Size: $\Phi 82 \times 117$
Thread: M16*1.5
Application: SCANIA, VOLVO, MECO, MAN

FLEETGUARD: FF42000
HENGST:
MANN: WK 723/6
BALDWIN:
DONALDSON: P553004



MJC-039

OE NO.: LF4054
Size: $\Phi 93 \times 222$
Thread: 1"-12UNF
Application: Volvo, DAF, Ford

FLEETGUARD: LF4054
HENGST: H18W01
MANN: W 962
BALDWIN: B7143
DONALDSON: P553771



MCC-223

OE NO.: FF2200
Size: $\Phi 95 \times 229$
Thread: M72x2
Application: Cummins ISX Series Engines; International, Kenworth, Mack, Peterbilt, Volvo Trucks

FLEETGUARD: FF2200
HENGST:
MANN:
BALDWIN: BF7766
DONALDSON: P552200



MCE-173

OE NO.: MCE-173
Size: $\Phi 110 \times 181.5$
Thread: 1"-14UNS-2B
Application: Volvo Trucks

FLEETGUARD: FS19551
HENGST: H704WK
MANN: WK1060/Sx
BALDWIN: BF1390-
DONALDSON: P551066



MJC-034

OE NO.: W940/S
Size: $\Phi 95 \times 139$
Thread: 1-12 UN
Application: Demag Compressors; Volvo Loaders

FLEETGUARD: LF4056
HENGST: H17W04
MANN: W940/18
BALDWIN: BT292
DONALDSON: P559418



MCB-030

OE NO.: 26561118
Size: $\Phi 86.7 \times 155$
Thread: M16x1.5
Application: Deutz, Volvo-Penta Engines; Case, Ford, International, John Deere, New Holland Equipment

FLEETGUARD: FF5135
HENGST: H70WK02
MANN: WK 842/2
BALDWIN: BF587D
DONALDSON:



MCE-153

OE NO.: H706WK
Size: $\Phi 110 \times 215.5$
Thread: 1"-14UNS-2B
Application: Volvo, Iveco

FLEETGUARD:
HENGST: H706WK
MANN: WK10002
BALDWIN:
DONALDSON:



MJE-156

OE NO.: WP11102/3
Size: $\Phi 109.5 \times 263$
Thread: 1-3/8"-16UN-28
Application: RENAULT TRUCKS, Volvo

FLEETGUARD:
HENGST: H200WN01
MANN: WP11102/3
BALDWIN: B7409
DONALDSON: P550425



MJC-136

OE NO.: LF3400
Size: $\Phi 95 \times 86$
Thread: 3/4"-16UNF
Application: Volvo

FLEETGUARD: LF3400
HENGST: H10W06
MANN: W917
BALDWIN:
DONALDSON: P550939



MJE-078

OE NO.: LF9667
Size: $\Phi 109.5 \times 263$
Thread: 1-1/8"-16
Application: DONGFENG, RENAULT TRUCKS, VOLVO

FLEETGUARD: LF9667
HENGST:
MANN: H200W03/H200W04
BALDWIN:
DONALDSON: P553191



MJE-157

OE NO.: W11102/36
Size: $\Phi 108 \times 262$
Thread: 1 1/8-16 UN
Application: VOLVO

FLEETGUARD:
HENGST: H200W10
MANN: W11102/36
BALDWIN:
DONALDSON:



MCE-075

OE NO.: WDK11102/23
Size: $\Phi 109.5 \times 263$
Thread: M32*1.5
Application: Mack Engines, Trucks; Volvo Buses, Engines, Trucks

FLEETGUARD: FF5507
HENGST: H200W0K
MANN: WDK11102/23
BALDWIN: BF7814
DONALDSON: P550529



MCC-033

OE NO.: WK962/7
Size: $\Phi 95 \times 210$
Thread: M18*1.5
Application: Volvo

FLEETGUARD: FF5272
HENGST: H18WK03
MANN: WK 962/7
BALDWIN: BF7653
DONALDSON: P550372



MCE-049

OE NO.: 11110474
Size: $\Phi 107.5 \times 217.5$
Thread: 1"-14UNS-28
Application: Volvo

FLEETGUARD: FS19753
HENGST:
MANN: WK 1176 x
BALDWIN:
DONALDSON:



MCE-059

OE NO.: 22474709
Size: $\Phi 110 \times 263$
Thread: M32 x 1.5
Application: VOLVO, RENAULT TRUCKS

FLEETGUARD: FF5507
HENGST: H200W0K
MANN: WDK111029
BALDWIN: 8F46117
DONALDSON:



MCE-190

OE NO.: 23856886
Size: $\Phi 110 \times 228$
Thread: M32*1.56H
Application: Mack, Volvo, Renault

FLEETGUARD: FF42128NN
HENGST:
MANN:
BALDWIN:
DONALDSON:



MJE-162

OE NO.: 23385011
Size: Φ 110*262.5
Thread: M32*1.5-6H
Application: Volvo

FLEETGUARD: LF16465
HENGST:
MANN:
BALDWIN:
DONALDSON:



MSC-013

OE NO.: 21937327
Size: Φ 94*107
Thread: M16*1.5-6H
Application: Volvo Equipment

FLEETGUARD: WF2129
HENGST:
MANN:
BALDWIN: 85145
DONALDSON: ECF4081



MCC-174

OE NO.: FF5935
Size: Φ 96.5*212
Thread: 1"-12UNF-2B
Application: Volvo, Volkswagen

FLEETGUARD: FF5935
HENGST: H333WK
MANN: WK962/13
BALDWIN:
DONALDSON: P551523



MCC-156

OE NO.: WK940/S
Size: Φ 93*141
Thread: M16X1.5
Application: Volvo Equipment

FLEETGUARD: FF5709
HENGST: H17WK10
MANN: WK940/5 / WK940/19
BALDWIN: BF7888
DONALDSON: P554620



MCB-001

OE NO.: PC42
Size: Φ 78.5*113
Thread: M16*1.5-6H
Application: Deutz, Volvo Engines; R.V.I. Trucks

FLEETGUARD: FF5018/FF5052
HENGST: H60WK01
MANN: WK731
BALDWIN: BF988
DONALDSON:



MHF-086

OE NO.: 5223958455
Size:
Thread:
Application: Nissan, Volvo Trucks

REFERENCE NO.: 152049Z00C
HENGST:
MANN:
BALDWIN:
DONALDSON:



MCE-225

OE NO.: 21632237
Size: Φ 108*182
Thread: M32X1.5
Application: Volvo

FLEETGUARD: FF262
HENGST:
MANN: WDK11001
BALDWIN:
DONALDSON:



MCE-224

OE NO.: 23879441
Size: Φ 112*130
Thread: 1"-14UNS-2B
Application: Volvo

FLEETGUARD:
HENGST:
MANN:
BALDWIN:
DONALDSON:



MJC-297

OE NO.: 6675517
Size: Φ 93*97
Thread: 3/4-16 UNF
Application: Toyota, Bobcat, Volvo

FLEETGUARD: LF3400
HENGST: H10W11
MANN: W920/80
BALDWIN: B163
DONALDSON:



MCE-193

OE NO.: H421WK
Size: Φ 110*168
Thread: M32*1.5-6H
Application: Volvo

FLEETGUARD: FF5987
HENGST: H421WK
MANN:
BALDWIN:
DONALDSON:



MCE-140-200

OE NO.: BF8X9155AA
Size: Φ 108*190
Thread: 1-14 UNS
Application: Volkswagen, Ford, Mercedes-Benz, Iveco

FLEETGUARD:
HENGST:
MANN: WK 1040
BALDWIN:
DONALDSON:



MCE-139-200

OE NO.: WK1060/1
Size: Φ 108*276
Thread: 1-14 UNS
Application: Benz, King Long, Volvo

FLEETGUARD:
HENGST: H7090WK30
MANN: WK1060/1
BALDWIN:
DONALDSON:



MCE-158A-200

OE NO.: 7147701
Size: Φ 108*258
Thread: 1-12 UNF
Application: Benz, Iveco

FLEETGUARD:
HENGST:
MANN: WK 1050/1
BALDWIN:
DONALDSON:



MCE-079A-200

OE NO.: A 384 477 70 15
Size: Φ 108*276
Thread: 1-12 UNF
Application: Benz

FLEETGUARD:
HENGST:
MANN: WK 1060/2
BALDWIN:
DONALDSON:



MCE-020-200

OE NO.: R60P
Size: Φ 110x208.5
Thread: 1"-14
Application: Freightliner, Ford, Hino, Mercedes-Benz

FLEETGUARD: FS1287
HENGST:
MANN:
BALDWIN: BF46147-0
DONALDSON:



MCE-044-200

OE NO.: R90T-D MAX
Size: Φ 112*255
Thread: 1-14"UNF-2B
Application: HYUNDAI, MERCEDES BENZ, VOLVO

FLEETGUARD: FS19593
HENGST: H7091WK10
MANN: WK1070X
BALDWIN: BF1292-0
DONALDSON:



MCE-002

OE NO.: PL420
Size: Φ 110*220
Thread: 1"-14UNS
Application: MERCEDES-BENZ, VOLVO, MAN

FLEETGUARD: FS19769
HENGST: H701WK
MANN: WK1080/7x / PL420/7x
BALDWIN: BF13830
DONALDSON: P550778



MCE-036

OE NO.: R90-MER-01
Size: Φ 112*219
Thread: 1"-14UNS-2B
Application: Mercedes-Benz, FORD

FLEETGUARD: FS19914
HENGST: H701WK
MANN: WK 1080/7x
BALDWIN:
DONALDSON:



MCE-005

OE NO.: FS19737
Size: Φ 110*219
Thread: 1"-14
Application: Doppstadt AK430 Shredder with Mercedes-Benz OM501LA Engine

FLEETGUARD: FS19737
HENGST: H7160WK30
MANN: WK 1080/6 x
BALDWIN: BF1363
DONALDSON: P550778



MCE-084

OE NO.: WK1060/4
Size: Φ 109.5*180
Thread: 1"-12UNF
Application: MERCEDES-BENZ

FLEETGUARD:
HENGST: H7118WK10
MANN: WK1060/4
BALDWIN:
DONALDSON:

MERCEDES-BENZ



MCE-043

OE NO.: A4570920001
Size: Φ112*158
Thread: 1"-12UNF-2B
Application: Mercedes-Benz

FLEETGUARD: FS20028
HENGST:
MANN: WK1050/1
BALDWIN: BF1360-O
DONALDSON: P551854



MCE-165

OE NO.: A3760927001KZ
Size: Φ110X181
Thread: 1"-14UNS-2B
Application: DAF; MERCEDES-BENZ;
SCANIA; VOLVO

FLEETGUARD: FS19930
HENGST: H233WK
MANN:
BALDWIN:
DONALDSON:



MCE-150

OE NO.: A3760927301KZ
Size: Φ110*212
Thread: 1"-14UNS2B
Application: Carrier-Transcold, Ford,
Hino Trucks; MERCEDES-BENZ

FLEETGUARD:
HENGST: H466WK
MANN: WK1156/1
BALDWIN:
DONALDSON: P551026



MCE-164

OE NO.: PS10610
Size: Φ112*219
Thread: 1"-14UNS-2B
Application: Mercedes-Benz

FLEETGUARD: PS10610
HENGST:
MANN:
BALDWIN:
DONALDSON:



MCE-154

OE NO.: FS19932
Size: Φ110*203
Thread: 1"-14UNS-2B
Application: Ford, Freightliner,
International, Sterling, Western Star
Trucks; Mercedes-Benz Engines

FLEETGUARD: FS19932
HENGST: H233WK
MANN: WK1156/1
BALDWIN: BF1346
DONALDSON:



MCE-231

OE NO.: FS20041
Size: Φ110*202
Thread: 1"-12UNF
Application: Mercedes-Benz

FLEETGUARD: FS20041
HENGST:
MANN:
BALDWIN:
DONALDSON:



MCC-159

OE NO.: FS1241
Size: Φ95*119
Thread: 1"-14UNS-2B
Application: Ford, Mercedes-Benz

FLEETGUARD: FS1241
HENGST:
MANN:
BALDWIN:
DONALDSON:



MCB-047

OE NO.: 10922302
Size: Φ83.5*103
Thread: M12*1.5-6H
Application: Mercedes-Benz
Automotive

FLEETGUARD: FF5373
HENGST:
MANN:
BALDWIN: BF7619
DONALDSON:



MHD-006

OE NO.: A5410900151
Size: Φ105*204
Thread:
Application: MERCEDES-BENZ Trucks,
FREIGHTLINER

FLEETGUARD: FF5405
HENGST: E500KP02D36
MANN: PU999/1X
BALDWIN: PF7761
DONALDSON: P550762



MHF-011

OE NO.: A4571840125
Size: Φ121*248
Thread:
Application: MERCEDES-BENZ

FLEETGUARD: LF16046
HENGST: E175H D129
MANN: HU12110X
BALDWIN: P7230
DONALDSON:



MHC-104

OE NO.: 0004774515
Size: Φ82*Φ13.5*137
Thread:
Application: Iveco, M.A.N.,
Mercedes-Benz, Scania-Vabis, Volvo
Buses, Trucks

FLEETGUARD: FF147
HENGST: E10KPD10
MANN: P811
BALDWIN: PF950
DONALDSON: P550861



MHC-105

OE NO.: 4220920005
Size: Φ82*Φ13.5*145
Thread:
Application: Mercedes-Benz, Scania,
Kassbohrer, Volvo Buses, Trucks

FLEETGUARD: FF5054
HENGST: E10KFR4 D10
MANN: 8F811 / 8FU900x
BALDWIN: F950-F
DONALDSON: P550489



MHC-036

OE NO.: 3661840125
Size: Φ83*199
Thread:
Application: MERCEDES-BENZ,
NEOPLAN Starliner

FLEETGUARD: LF3573
HENGST: E197HD23
MANN: HU947/1Z2
BALDWIN: P7016
DONALDSON:



MHF-050

OE NO.: 5105504-0091
Size: Φ120*Φ56*194
Thread:
Application: Mercedes-Benz Engines
Equipment

FLEETGUARD: LF3320
HENGST: E174HD11
MANN: H1275x
BALDWIN: P242
DONALDSON: P558425



MHF-013

OE NO.: H12110/2
Size: Φ120*Φ56*270
Thread:
Application: M.A.N., Mercedes-Benz,
R.V.I. Buses, Engines, Trucks

FLEETGUARD: LF3327
HENGST: E251H D11
MANN: H12110/2
BALDWIN: P294
DONALDSON:



MHE-008

OE NO.: E243HD13
Size: Φ100*244.5
Thread:
Application: Mercedes-Benz Buses,
Trucks, Vans

FLEETGUARD: LF3350
HENGST: E243HD13
MANN: H1076x
BALDWIN: P7052
DONALDSON:



MHF-003

OE NO.: CH956
Size: Φ118*Φ56*197
Thread:
Application: Claas Combines; M.A.N.,
R.V.I. Trucks; Mercedes-Benz Buses,
Trucks; Zettelmeyer Equipment

FLEETGUARD: LF4105
HENGST:
MANN:
BALDWIN: P721
DONALDSON:



MHA-014

OE NO.: A6111800009
Size: Φ64.8*113
Thread:
Application: JEEP, Mercedes-Benz

FLEETGUARD: LF3997
HENGST: E11HD57
MANN: HU718/1K
BALDWIN: P7198
DONALDSON: P550564



MHA-025

OE NO.: 10418402225
Size: Φ63*Φ25.5*160.5
Thread:
Application: Mercedes-Benz
Automotive

FLEETGUARD:
HENGST: E142H D21
MANN: HU 727/1 x
BALDWIN: P1419
DONALDSON:



MHA-035

OE NO.: 2711800009
Size: Φ47*Φ20*158
Thread:
Application: Mercedes-Benz

FLEETGUARD: LF16450
HENGST: E38H D106
MANN: HU 514x
BALDWIN:
DONALDSON:



MHF-066

OE NO.: E824HD264
Size: Φ114*300
Thread:
Application: Mercedes-Benz

FLEETGUARD: LF17548
HENGST: E824H D264
MANN: HU 12006 Z
BALDWIN:
DONALDSON:



MHC-025

OE NO.: A9061800209
Size: Φ83*209
Thread:
Application: Equipment Trucks with
Deutz, Mercedes-Benz Engines; Fendt
Tractors

FLEETGUARD: LF3914
HENGST: E161H01 D28
MANN: HU 945/2 x
BALDWIN: P7188
DONALDSON: P550761



MHC-037

OE NO.: A0001801609
Size: Φ82.5*152
Thread:
Application: Buses, Trucks with
Mercedes-Benz Engines

FLEETGUARD: LF3827
HENGST: E160H01 D28
MANN: HU931/5X
BALDWIN: P7199
DONALDSON: P550768



MHF-023

OE NO.: A4571840025
Size: Φ121*311
Thread:
Application: MERCEDES-BENZ

FLEETGUARD: LF3829
HENGST: E500HD129
MANN: HU12140x
BALDWIN: P7192
DONALDSON: P550453



MHD-036

OE NO.: A4000920005
Size: $\Phi 91.3 \times \Phi 21 \times 108$
Thread:
Application: Mercedes-Benz

FLEETGUARD:
HENGST:
MANN:
BALDWIN:
DONALDSON:



MHD-055

OE NO.: 90.541151.0038
Size:
Thread:
Application: MERCEDES-BENZ

FLEETGUARD: LF16349
HENGST:
MANN: HU952x
BALDWIN:
DONALDSON:



MCC-072

OE NO.: FS1234
Size: $\Phi 95 \times 120$
Thread: 1"-14UNF-2B
Application: Freightliner, Ford, Hino, Mercedes-Benz

FLEETGUARD: FS1234
HENGST: H703WK
MANN: WK 933 x
BALDWIN: BF1204-O
DONALDSON: P550088



MJC-262

OE NO.: BC7326
Size: $\Phi 98.5 \times 146.8$
Thread:
Application: Freightliner, Kenworth, Peterbilt, Sterling Trucks; Mercedes-Benz, Paccar Engines

FLEETGUARD: CS41008
HENGST: Z16D183
MANN: ZR905Z
BALDWIN: BC7326
DONALDSON:



MHC-029

OE NO.: HU1077/1Z
Size: $\Phi 90 \times \Phi 45 \times 282$
Thread:
Application: Scania Engines, Trucks

FLEETGUARD: LF17486
HENGST: E123H01 D194
MANN: HU1077/1Z
BALDWIN: P7502
DONALDSON: P953329



MHC-033

OE NO.: PU 941 x
Size: $\Phi 85 \times 188.5$
Thread:
Application: Scania Generator Sets, Trucks

FLEETGUARD: FF5683
HENGST: E57KP D73
MANN: PU 941 x
BALDWIN: PF7896
DONALDSON: P550628



MHC-032

OE NO.: 1873016
Size: $\Phi 85 \times 185.5$
Thread:
Application: Scania Trucks

FLEETGUARD: FF5684
HENGST: E68KP01D73
MANN: PU 941/1X
BALDWIN: PF7936
DONALDSON: P550653



MCC-062

OE NO.: 1372444
Size: $\Phi 95 \times 145$
Thread: M24*1.5-6H
Application: SCANIA, MERCEDES-BENZ

FLEETGUARD: FF5297
HENGST: H17WK04
MANN: WK 940/12
BALDWIN: BF7624
DONALDSON:



MJE-005

OE NO.: 1117285
Size: $\Phi 109.5 \times 263$
Thread: 1-1/8"-16
Application: SCANIA, RENAULT TRUCKS, DAF, VOLVO

FLEETGUARD:
HENGST: H200W02/H200W20
MANN: W 11102/18 W 11102/37
BALDWIN:
DONALDSON: P550490



MCB-131

OE NO.: 364624
Size: $\Phi 80 \times 121$
Thread: M16 X1.5-6H
Application: RENAULT TRUCKS; VOLVO; SCANIA; IVECO; MAN; DAF

FLEETGUARD: FF5074
HENGST: H60WK08
MANN: WK 723
BALDWIN: BF988
DONALDSON: P553004



MCE-042

OE NO.: 1518512
Size: $\Phi 112 \times 180$
Thread: 1"-14UNF
Application: KING LONG XMQ; VOLVO FM; SCANIA; FREIGHTLINER

FLEETGUARD: FS19551
HENGST: H7090WK10
MANN: WK 1060/2
BALDWIN: BF1294-O
DONALDSON: P550747



MCE-045

OE NO.: 1393640
Size: $\Phi 112 \times 158.5$
Thread: 1"-14UNF-2B
Application: CLAASARION; DAF; VOLVO; SCANIA; MERCEDES-BENZ; KING LONG; MAN

FLEETGUARD: FS19532
HENGST: H7090WK30
MANN: WK 1060/1 /WK 1060/3 x
BALDWIN: BF1329-O
DONALDSON: P550747



MJC-056

OE NO.: LF3376
Size: $\Phi 95 \times 97$
Thread: 3/4"-16
Application: Scania, Caterpillar, Kubota, Volvo

FLEETGUARD: LF3376
HENGST: H10W02
MANN: W 920/7
BALDWIN: B7298
DONALDSON: P550318



MCB-017

OE NO.: FF214
Size: $\Phi 86 \times 154$
Thread: M16*1.5
Application: IVECO VOLVO, FIAT, MAN, RENAULT TRUCKS, SCANIA, DEUTZ-FAHR

FLEETGUARD: FF214
HENGST: H70WK
MANN: WK 842
BALDWIN: BF587
DONALDSON: P550588

SCANIA



MCC-229

OE NO.: 1763776
Size: $\Phi 93.2 \times 145$
Thread: M24X1.5
Application: Scania

FLEETGUARD: FF5626
HENGST: H17WK11
MANN: WK940/10 / WK940/2
BALDWIN: BF7908
DONALDSON: P550515



MHD-008

OE NO.: E21HD74
Size: $\Phi 102.2 \times 252$
Thread:
Application: Scania Generator Sets, Trucks

FLEETGUARD: LF17487
HENGST: E21H D74
MANN: HU1072x
BALDWIN: P7319
DONALDSON: P550629



MHC-073

OE NO.: E101KP
Size: $\Phi 85 \times \Phi 37 \times 228$
Thread:
Application: Scania

FLEETGUARD:
HENGST: E101KP
MANN: PU10003/2x
BALDWIN: PF9829
DONALDSON:



MCE-226

OE NO.: 320-07426
Size: $\Phi 112 \times 266$
Thread:
Application: JCB

FLEETGUARD:
HENGST:
MANN:
BALDWIN:
DONALDSON:



MCB-242

OE NO.: 320/A7188
Size: $\Phi 84 \times 200$
Thread:
Application: JCB

FLEETGUARD:
HENGST:
MANN:
BALDWIN:
DONALDSON:



MCB-243

OE NO.: 320/A7250
Size: $\Phi 84 \times 250$
Thread:
Application: JCB

FLEETGUARD:
HENGST:
MANN:
BALDWIN:
DONALDSON:



MCB-060

OE NO.: 32-912001A
Size: $\Phi 85 \times 155$
Thread: 3M16*1.5
Application: JCB

FLEETGUARD:
HENGST: H70WK02
MANN: WK 842/2
BALDWIN:
DONALDSON:



MJC-087

OE NO.: 02/100284
Size: $\Phi 93 \times 142$
Thread: 3/4"-16
Application: JCB

FLEETGUARD:
HENGST: H17W06
MANN: W 940/24
BALDWIN: BT216
DONALDSON:



MJC-086

OE NO.: 02-100073
Size: $\Phi 93 \times 177$
Thread: 3/4"-16
Application: JCB

FLEETGUARD:
HENGST: H19W04
MANN: W 950/7
BALDWIN: BT237
DONALDSON:



MCB-092

OE NO.: 32-925694A
Size: $\Phi 131.5 \times 257.6$
Thread:
Application: JCB

FLEETGUARD:
HENGST:
MANN: WK8113
BALDWIN: BF7956-D
DONALDSON:



MCB-164

OE NO.: 32/925994
Size: $\Phi 88 \times 196$
Thread:
Application: JCB

FLEETGUARD: FS19993
HENGST:
MANN: WK8193
BALDWIN: BF7950-D
DONALDSON:



MCB-171

OE NO.: 32/925915
Size: $\Phi 88 \times 135$
Thread:
Application: JCB

FLEETGUARD: FS19987
HENGST:
MANN: WK8169
BALDWIN:
DONALDSON:



MJC-174

OE NO.: 320/04133
Size: $\Phi 93 \times 170$
Thread: M 22 X 1.5
Application: JCB

FLEETGUARD:
HENGST:
MANN:
BALDWIN:
DONALDSON:



MCB-120

OE NO.: 32-925950
Size: Ø88*197
Thread:
Application: JCB

FLEETGUARD:
HENGST:
MANN:
BALDWIN:
DONALDSON:



MJC-141

OE NO.: 581-18076
Size: Ø93*121
Thread: 1X12
Application: JCB

FLEETGUARD:
HENGST:
MANN:
BALDWIN:
DONALDSON:



MCB-098

OE NO.: 320/07155
Size: Ø80*175
Thread:
Application: JCB

FLEETGUARD:
HENGST:
MANN:
BALDWIN:
DONALDSON:



MCB-152

OE NO.: 320/07394
Size: Ø80*148
Thread:
Application: JCB

FLEETGUARD:
HENGST:
MANN:
BALDWIN:
DONALDSON:



MCC-132

OE NO.: FS19732
Size: Ø95.5*203
Thread: 1"-14
Application: JCB, Case IH, Cummins Engines

FLEETGUARD: FS19732
HENGST:
MANN:
BALDWIN: BF1385SPS
DONALDSON: P550848



MJF-004

OE NO.: LF3542
Size: Ø121*205
Thread: 1-3/8"-16
Application: Jcb, Isuzu, Hitachi, Hino

FLEETGUARD: LF3542
HENGST:
MANN: W12250
BALDWIN: B7577
DONALDSON: P550777



MJG-007

OE NO.: 86546615
Size: Ø138.5*153
Thread: 1-1/8"-16
Application: New Holland, Ford

FLEETGUARD: LF3360
HENGST: H212W
MANN:
BALDWIN: BT343
DONALDSON: P550157



MCC-064

OE NO.: 84217953
Size: Ø97*125
Thread: M14X1.5
Application: NEW HOLLANDTL

FLEETGUARD: FS19504
HENGST: H289WK
MANN: WK 9029
BALDWIN:
DONALDSON:



MCC-063

OE NO.: 87712547
Size: Ø95*167
Thread: 1"-12UNF-2B
Application: New Holland

FLEETGUARD: FS1090
HENGST:
MANN:
BALDWIN:
DONALDSON:



MJC-106

OE NO.: 87800068
Size: Ø96*95
Thread: 3/4-16 UN
Application: Ford, Caterpillar, New Holland Equipment, Land Rover Light-Duty Trucks

FLEETGUARD: LF4016
HENGST: H10W01
MANN: W 920/21
BALDWIN: B74
DONALDSON: P550939



MCB-237

OE NO.: 320/07382
Size: Ø80*160
Thread:
Application: JCB

FLEETGUARD:
HENGST:
MANN:
BALDWIN:
DONALDSON: P553550



MCD-009

OE NO.: 320/A7227
Size:
Thread:
Application: JCB

FLEETGUARD:
HENGST:
MANN:
BALDWIN:
DONALDSON:



MCE-020

OE NO.: FS19687
Size: Ø110*137
Thread: 1"-14
Application: Ford, New Holland Equipment

FLEETGUARD: FS19687
HENGST: H7060WK10
MANN: WK 1040
BALDWIN: BF1231
DONALDSON:



MCB-149

OE NO.: FS19972
Size: Ø79.3*154
Thread:
Application: Case, Case-International, John Deere, New Holland Equipment

FLEETGUARD: FS19972
HENGST:
MANN: WK8137
BALDWIN: BF7954-D
DONALDSON:



MCB-255

OE NO.: H531WK
Size: Ø89*127
Thread:
Application: JCB Equipment with 444 Diesel MaxEngine

FLEETGUARD: FS1069
HENGST:
MANN: WK8113
BALDWIN: BF7956-
DONALDSON: P551426



MJF-053

OE NO.: 581/18096
Size: Ø120*210
Thread: 1-1/2"-12UNF-2B
Application: JCB Equipment with Isuzu Engines

FLEETGUARD:
HENGST:
MANN:
BALDWIN:
DONALDSON:



MCB-088

OE NO.: FS19774
Size: Ø78*178
Thread: M16*1.5
Application: Case-International, New Holland Tractors

FLEETGUARD: FS19774
HENGST:
MANN: WK 8044x
BALDWIN: BF7998
DONALDSON:



MJC-081

OE NO.: LF3861
Size: Ø95*178
Thread: 1"-12
Application: Case-International, New Holland Equipment

FLEETGUARD: LF3861
HENGST:
MANN: W 950/17
BALDWIN: B7215
DONALDSON:



MHA-026

OE NO.: 32/922300
Size: Ø71.5*80
Thread:
Application: JCB

FLEETGUARD:
HENGST:
MANN:
BALDWIN:
DONALDSON:



MCC-141

OE NO.: FF5612
Size: Ø95.5*178
Thread: M20*1.5
Application: Case-International, New Holland Equipment

FLEETGUARD: FF5612
HENGST:
MANN: WK 929
BALDWIN: BF7922
DONALDSON: P550880



MCB-073

OE NO.: FS19864
Size: Ø84*195
Thread:
Application: New Holland Tractors

FLEETGUARD: FS19864
HENGST: H277WK
MANN: WK 8123
BALDWIN:
DONALDSON:

NEW HOLLAND



MJC-235

OE NO.: LF3331
Size: $\Phi 94.5 \times 177.5$
Thread: 1"-12UNF-2B
Application: New Holland, Case IH

FLEETGUARD: LF3331
HENGST: H1 9W07
MANN: W950/17
BALDWIN:
DONALDSON: P557207



MCC-215

OE NO.: FS19927
Size: $\Phi 94.5 \times 194$
Thread: M16*1.5
Application: New Holland Case IH

FLEETGUARD: FS19927
HENGST:
MANN: WK 9048 x
BALDWIN:
DONALDSON:



MHE-021

OE NO.: 5801592277
Size: $\Phi 104.5 \times \Phi 40.5 \times 324$
Thread:
Application: Case IH, New Holland, Astra

FLEETGUARD: LF17546
HENGST:
MANN:
BALDWIN: P40062
DONALDSON:



MJC-293

OE NO.: LF16117
Size: $\Phi 95 \times 173$
Thread: M27*2
Application: Case-International, New Holland Tractors

FLEETGUARD: LF16117
HENGST:
MANN: W9019
BALDWIN: B7327
DONALDSON:



MCC-230

OE NO.: 5801364481
Size: $\Phi 94.5 \times 213$
Thread: M16*1.5-6H
Application: New Holland

FLEETGUARD: FF5457
HENGST:
MANN: WOK962/16
BALDWIN: BF7696
DONALDSON:



MCB-003

OE NO.: 47135706 /13020488
Size: $\Phi 83 \times 155$
Thread: M16X1.5
Application: Iveco, Scania, New Holland, Volvo

FLEETGUARD: FF5135
HENGST: H70WK02
MANN: WK 842/2
BALDWIN: BF5587-D
DONALDSON: P550588



MHE-010

OE NO.: 5801439820
Size: $\Phi 109 \times 162$
Thread:
Application: Case, Case-International, New Holland Equipment

FLEETGUARD: FF5857
HENGST:
MANN: PU10020 x
BALDWIN:
DONALDSON:



MCB-015

OE NO.: 26560145
Size: $\Phi 79 \times 125$
Thread: 3/8"-16UNF
Application: Caterpillar, Perkins Engines; New Holland Tractors

FLEETGUARD: FS19530
HENGST: H183WK
MANN: WK 8122
BALDWIN: BF7681-D
DONALDSON: P550399



MCB-008

OE NO.: 26561117
Size: $\Phi 88 \times 71.5$
Thread:
Application: Ford, Iveco, CATERPILLAR Equipment; Perkins Engine

FLEETGUARD: FF167
HENGST: E75K D42
MANN: P 917 x
BALDWIN:
DONALDSON:



MJG-011

OE NO.: 26540244
Size: $\Phi 138 \times 303$
Thread: M36X1.5-6H
Application: Perkins

FLEETGUARD: LF3883
HENGST: H300W05
MANN:
BALDWIN: B7030
DONALDSON: P550367



MJB-046

OE NO.: 140517050
Size: $\Phi 78.5 \times 82$
Thread: 3/4"-16UNF-2B
Application: Perkins

FLEETGUARD:
HENGST: H90W20
MANN: W 712/B3
BALDWIN:
DONALDSON: P502016



MJB-037

OE NO.: 2654408
Size: $\Phi 78.5 \times 147$
Thread: 3/4"-16UNF-2B
Application: JCB, Massey Ferguson, Perkins

FLEETGUARD: LF700
HENGST:
MANN: H14W03
BALDWIN: BT215
DONALDSON:



MCE-031

OE NO.: 26560137
Size: $\Phi 110 \times 178$
Thread: 7/8"-14UNF-2B
Application: International, Perkins

FLEETGUARD: FF5078
HENGST:
MANN:
BALDWIN: BF362
DONALDSON:



MJC-079

OE NO.: 2654407
Size: $\Phi 95 \times 171$
Thread: 3/4"-16
Application: Bobcat, Caterpillar, JCB, Komatsu, Landini, Massey Ferguson Equipment; Perkins Engines

FLEETGUARD: LF699
HENGST: H19W04
MANN: W950/7
BALDWIN: BT237
DONALDSON: P554407



MHF-005

OE NO.: CH10931/996454
Size: $\Phi 125 \times 265.5$
Thread:
Application: Perkins

FLEETGUARD: FF5713
HENGST:
MANN:
BALDWIN: PF7900
DONALDSON: P502479



MHF-006

OE NO.: CH10929/996452
Size: $\Phi 125 \times 270$
Thread:
Application: PERKINS

FLEETGUARD: LF16250
HENGST:
MANN:
BALDWIN: P7321
DONALDSON: P502477



MHF-007

OE NO.: CH10930/996-453
Size: $\Phi 115 \times 238$
Thread:
Application: PERKINS

FLEETGUARD: FF5714
HENGST:
MANN:
BALDWIN: PF7899
DONALDSON: P502478

PERKINS



OE NO.: 7111-296
Size: $\Phi 88 \times 71.5$
Thread:
Application: International, JCB, John Deere, Kubota, Massey Ferguson, New Holland, Oliver, Perkins

FLEETGUARD: FF167A
HENGST: E75K D42
MANN: P 917 x
BALDWIN: BF825
DONALDSON: P556245

MCB-034



OE NO.: 7111-796
Size: $\Phi 88 \times 112$
Thread:
Application: Agco, Ford, JCB, Massey Ferguson, New Holland, Volvo

FLEETGUARD: FF4052A
HENGST: E76K D42
MANN: P945x
BALDWIN: BF884
DONALDSON: P556287

MCB-045



OE NO.: 26560163
Size: $\Phi 75 \times \Phi 34 \times 116$
Thread:
Application: PERKINS

FLEETGUARD:
HENGST:
MANN:
BALDWIN:
DONALDSON:

MHB-018



OE NO.: 26560201
Size: $\Phi 75 \times \Phi 34 \times 159$
Thread:
Application: Perkins

FLEETGUARD:
HENGST:
MANN:
BALDWIN:
DONALDSON:

MHB-017



OE NO.: 4461492
Size: $\Phi 124 \times 263$
Thread:
Application: Perkins

FLEETGUARD:
HENGST:
MANN:
BALDWIN:
DONALDSON:

MHA-018



OE NO.: 2654403
Size: $\Phi 97 \times 139.5$
Thread: 3/4 - 16 UNF
Application: Bobcat, Caterpillar, Claas, J.C.B, Massey Ferguson, New Holland, Volvo Equipment, Perkins Engines

FLEETGUARD: LF701
HENGST: H17W06
MANN: W940
BALDWIN: BT216
DONALDSON: P554403

MJC-048



OE NO.: 1902138
Size: $\Phi 83 \times 155$
Thread: M16X1.5
Application: IVECO, New Holland, FORD, VOLVO

FLEETGUARD: FF5135
HENGST: H70WK02
MANN: WK 842/2
BALDWIN: BF5587-D
DONALDSON: P550588

MCB-048



OE NO.: 2992242
Size: $\Phi 93.5 \times 174$
Thread: M27x2
Application: IVECO, BMW, FORD, DAF

FLEETGUARD: LF16015
HENGST: H19W10
MANN: W950/26
BALDWIN: BT7237
DONALDSON:

MJC-103



OE NO.: 2992544
Size: $\Phi 110 \times 230$
Thread: M30*2
Application: IVECO

FLEETGUARD: LF3977
HENGST: H230W
MANN: W1170/7
BALDWIN:
DONALDSON: P550639

MJE-056



OE NO.: 2994048
Size: $\Phi 110 \times 172$
Thread: M16*1.5
Application: IVECO

FLEETGUARD: FF5471
HENGST: H152WK
MANN:
BALDWIN: BF7927
DONALDSON: P763995

MCE-035



OE NO.: 1901605
Size: $\Phi 108 \times 186$
Thread: 3/4"-16 UNF
Application: IVECO, Man

FLEETGUARD: FF5039
HENGST: H19WK02
MANN: WK 1168
BALDWIN: BF783
DONALDSON: P551605

MCE-052



OE NO.: 1902047 / 1903628
Size: $\Phi 110 \times 145$
Thread: 3/4"-16 UNF
Application: IVECO, RENAULT TRUCK

FLEETGUARD: LF3481
HENGST: H210WN
MANN: WP 1144
BALDWIN: BD232
DONALDSON: P550226

MJE-021



OE NO.: 1903629
Size: $\Phi 108 \times 213$
Thread: M30X2
Application: IVECO

FLEETGUARD: LF3594
HENGST: H220WN
MANN: WP 1169
BALDWIN: BD325
DONALDSON: P550342

MJE-029



OE NO.: 1909101
Size: $\Phi 107 \times 180$
Thread: 3/4"-16 UNF
Application: IVECO Zeta

FLEETGUARD: LF3347
HENGST: H210W02
MANN: W 80B5
BALDWIN: BT347
DONALDSON: P551603

MJE-027



OE NO.: 2992241
Size: $\Phi 93 \times 209$
Thread: M20X1.5
Application: DAF, FORD, Nissan, IVECO

FLEETGUARD: FF5485
HENGST: H18WK05
MANN: WK 950/21
BALDWIN: BF7957
DONALDSON: P550881

MCC-054



OE NO.: 2997378
Size: $\Phi 111 \times 220$
Thread: 1-14 UNF-2B
Application: IVECO, benz VOLVO

FLEETGUARD: FS19914
HENGST:
MANN: W 940/62
BALDWIN: BF7957/BF7940
DONALDSON: P559118

MCE-076



MCB-004

OE NO.: FF5284
Size: $\Phi 78 \times 150$
Thread: M16 x 1.5
Application: Iveco

FLEETGUARD: FF5284
HENGST: H60WK09
MANN: WK724
BALDWIN: BF7663
DONALDSON:



MCC-076

OE NO.: BF1365
Size: $\Phi 95 \times 185$
Thread: M16X1.5-6H
Application: Iveco Trucks

FLEETGUARD: FS19821
HENGST: H215WK
MANN: WK950/19
BALDWIN: BF1365
DONALDSON: P550904



MJC-074

OE NO.: 1174418
Size: $\Phi 93 \times 154$
Thread: 1" X 12 UNF
Application: DEUTZ-FAHR, Iveco

FLEETGUARD: LF4056
HENGST: H17W04
MANN: W940/18
BALDWIN:
DONALDSON:



MCB-057

OE NO.: 01174423
Size: $\Phi 76 \times 119$
Thread: M16X1.5
Application: DEUTZ-FAHR, Iveco

FLEETGUARD:
HENGST: H60WK01
MANN: WK731
BALDWIN: BF7931
DONALDSON: P553004



MJE-023

OE NO.: LF4112
Size: $\Phi 116 \times 263$
Thread: 1-1/8" - 16
Application: DEUTZ-FAHR, IVECO, KAMAZ, RENAULT, MAN

FLEETGUARD: LF4112
HENGST: H200W
MANN: W11102
BALDWIN: B218
DONALDSON: P551102



MCC-099

OE NO.: FF165
Size: $\Phi 93 \times 164.5$
Thread: M20 x P1.5
Application: IVECO; KOMATSU; JCB; VOLVO

FLEETGUARD: FF165
HENGST:
MANN: WK724/4
BALDWIN:
DONALDSON: J06-22040



MJE-033

OE NO.: 1907570
Size: $\Phi 110 \times 223$
Thread: 1" - 12
Application: Allis Chalmers, Astra, Case Equipment; Fiat, Iveco Engines

FLEETGUARD: LF3346/LF3656
HENGST: H220W
MANN: W1170
BALDWIN: BT349/B263
DONALDSON: P551604



MJE-111

OE NO.: LF3373
Size: $\Phi 108 \times 184$
Thread: M30 X 2-6H INT
Application: IVECO

FLEETGUARD: LF3373
HENGST:
MANN: W1168/4
BALDWIN:
DONALDSON:



MCC-002

OE NO.: FS1254
Size: $\Phi 95 \times 190$
Thread: M14*1.5
Application: Iveco

FLEETGUARD: FS1254
HENGST: H70WK09
MANN: WK950/6
BALDWIN: BF1217
DONALDSON: P550665



MCC-096

OE NO.: FF231
Size: $\Phi 95.5 \times 138$
Thread: M16*1.5
Application: Agco, Bomag, Case, Claas, Deutz-Allis, Iveco, Poclain, Terex Equipment; DAF Buses, Trucks

FLEETGUARD: FF231
HENGST: H17WK02
MANN: WK940/5
BALDWIN: BF900
DONALDSON: P554620



MJE-041

OE NO.: 4741272
Size: $\Phi 107 \times 137$
Thread: M30X2
Application: Iveco

FLEETGUARD: LF3372
HENGST: H208W02
MANN: W1140/5
BALDWIN:
DONALDSON: P502222



MHF-044

OE NO.: 5801415504
Size: $\Phi 123 \times 235$
Thread:
Application: IVECO

FLEETGUARD: LF17547
HENGST:
MANN:
BALDWIN:
DONALDSON:



MCB-223

OE NO.: FS19982
Size: $\Phi 84.5 \times 199$
Thread: M16X1.5
Application: Agco, Case-International, J.C. Bamford, Massey Ferguson, New Holland, Valtra Equipment; Iveco Engines

FLEETGUARD: FS19982
HENGST:
MANN: WK8124
BALDWIN: BF7951-1
DONALDSON:



MCB-166

OE NO.: FS19781
Size: $\Phi 85 \times 186$
Thread: M16*1.56H
Application: 2005-06 Jeep Liberty; Iveco Light-Duty Trucks

FLEETGUARD: FS19781
HENGST: H160WK
MANN: WK854/2
BALDWIN: BF7970
DONALDSON: P550903



WG-051

OE NO.: 2996416
Size: $\Phi 136 \times 348$
Thread: S 126 X 4
Application: Iveco Trucks; Case-International Steiger, New Holland Equipment

FLEETGUARD:
HENGST: H311W
MANN: W13004
BALDWIN: P7495
DONALDSON:



WG-376

OE NO.: 5801457685/5801628021
Size:
Thread:
Application: IVECO

FLEETGUARD:
HENGST:
MANN:
BALDWIN:
DONALDSON:



MCE-134

OE NO.: RN-170
Size: $\Phi 111 \times 180$
Thread: 3/4" - 16 UNF - 2B
Application: Allis Chalmers, Astra, Benfra, Fiat Allis, New Holland Equipment; Iveco Buses, Engines Trucks

FLEETGUARD:
HENGST: H19WK02
MANN: WK1168
BALDWIN: BF783
DONALDSON:



MJC-095

OE NO.: 2995655
Size: $\Phi 94.5 \times 140$
Thread: M22*1.56H
Application: Iveco Daily, Mitsubishi Trucks

FLEETGUARD: LF17472
HENGST: H17W29
MANN: W940/69
BALDWIN: 87388
DONALDSON:



MCB-194

OE NO.: FF4136
Size: $\Phi 78 \times 117$
Thread: 3/4" - 16 UNF - 2B
Application: Renault, Iveco

FLEETGUARD: FF4136
HENGST: H19WK02
MANN: WK1168
BALDWIN: BF783
DONALDSON:



MHA-060

OE NO.: 5802050393
Size:
Thread:
Application: Iveco

FLEETGUARD: FF42147
HENGST:
MANN:
BALDWIN:
DONALDSON:



MJE-094

OE NO.: H220W
Size: $\Phi 111 \times 232$
Thread: 1" - 12 UNF - 2B
Application: Allis Chalmers, Astra, Case Equipment; Fiat, Iveco Engines

FLEETGUARD: LF3346
HENGST: H220W
MANN: W1170
BALDWIN: BT349
DONALDSON: P551604

RENAULT



MJE-005

OE NO.: 5000670700
Size: $\Phi 110 \times 263$
Thread: 1-1/8"-16
Application: DONGFENG; RENAULT TRUCKS; VOLVO; ERF; OAF

FLEETGUARD: LF3477
HENGST: H200W10
MANN: W 11 102/35
BALDWIN: 876-SS
DONALDSON: P553191



MJC-154

OE NO.: 5000670670
Size: $\Phi 93 \times 210$
Thread: 1"-12 UNF
Application: RENAULT TRUCKS

FLEETGUARD: LF3413
HENGST: H18W07
MANN: W 962/2
BALDWIN: 8403
DONALDSON: P550317



MCB-065

OE NO.: 5000686589
Size: $\Phi 76 \times 119$
Thread: M16x1.5
Application: DAF, RENAULT TRUCKS, SCANIA, VOLVO, Mack

FLEETGUARD: FF5167
HENGST: H60WK06
MANN: WK727
BALDWIN: 8F788
DONALDSON: P553004



MCE-103

OE NO.: FS19966
Size: $\Phi 110 \times 131$
Thread: 1"-14UNF-28
Application: RENAULT TRUCKS, VOLVO

FLEETGUARD: FS19966
HENGST: H392WK
MANN: WK100062
BALDWIN: 8F1386
DONALDSON: P550913



MJF-006

OE NO.: LF670
Size: $\Phi 120 \times 254$
Thread: 1-1/2"-12
Application: JOHN DEERE, ERF, RENAULT TRUCKS, VOLOVO

FLEET GUARD: LF670
HENGST: H240W
MANN: W1294
BALDWIN: 8196
DONALDSON: P551670



MCB-033

OE NO.: FF5018
Size: $\Phi 80 \times 121$
Thread: M16x1.5
Application: IVECO; VOLVO; VW; DEUTZ-FAHR; RENAULT TRUCKS

FLEETGUARD: FF5018
HENGST: H60WK01
MANN: WK 727
BALDWIN: 8F988
DONALDSON: P550491



MHC-010

OE NO.: FF5769
Size: $\Phi 95 \times 163.5$
Thread:
Application: RENAULT TRUCKS; VOLVO

FLEET GUARD: FF5769
HENGST: E416KP D36
MANN: PU1058X
BALDWIN: PF7938
DONALDSON:



MCC-049

OE NO.: 5010505337
Size: $\Phi 95.5 \times 145$
Thread: M18*1.5-6H
Application: DONGFENG, RENAULT

FLEETGUARD: FF5470
HENGST: H18WDK02
MANN: WK818
BALDWIN: 8F7886
DONALDSON: P550004



MJA-007

OE NO.: 87285
Size: $\Phi 68 \times 70$
Thread: M20*1.5
Application: NISSAN; HYUNDAI; RENAULT; MAZDA; FORD

FLEETGUARD:
HENGST: H97W06
MANN: W67/1
BALDWIN: 87285
DONALDSON:



MCB-091

OE NO.: 1457434106
Size: $\Phi 85.5 \times 158$
Thread: M16*1.5-6H
Application: RENAULT TRUCKS, Volkswagen, Fiat

FLEETGUARD:
HENGST: H70WK02
MANN: WK842
BALDWIN:
DONALDSON:



MJC-100

OE NO.: LF3402
Size: $\Phi 94 \times 143$
Thread: 3/4"-16UNF2B
Application: Hatz Diesel Engines; Renault Tractors

FLEETGUARD: LF3402
HENGST: H17W01
MANN: W 940
BALDWIN: 87156
DONALDSON: P550006



MHU-001

OE NO.: 5303604
Size: $\Phi 45 \times 93$
Thread:
Application: RENAULT TRUCKS, VOLVO

FLEETGUARD: UF101
HENGST:
MANN: U 5001 KIT
BALDWIN: PE17000
DONALDSON:



MJE-105

OE NO.: LF3481
Size: $\Phi 110 \times 143$
Thread: 3/4"-16UNF2B
Application: IVECO, OPEL, RENAULT, ALFA ROMEO, FIAT

FLEETGUARD: LF3481
HENGST: H210WN
MANN: WP1144
BALDWIN: 8D232
DONALDSON:

KAMAZ



MJE-150

OE NO.: 6w.23614.00
Size: Φ110*227.5
Thread: M32x2
Application: Kamaz

FLEETGUARD:
HENGST:
MANN: W11024
BALDWIN:
DONALDSON:



MJE-151

OE NO.: 6w.23.288.01
Size: Φ111*229
Thread: M30x2
Application: Kamaz

FLEETGUARD:
HENGST:
MANN:
BALDWIN:
DONALDSON:



MHF-064

OE NO.: 6w.26.084.00
Size: Φ109*Φ18*206
Thread:
Application: Kamaz

FLEETGUARD:
HENGST:
MANN:
BALDWIN:
DONALDSON:



MHF-063

OE NO.: 6w.25.169.00
Size: Φ122*Φ28*236
Thread:
Application: Kamaz

FLEETGUARD:
HENGST:
MANN:
BALDWIN:
DONALDSON:

JAPANESE / KOREAN SERIES

ISUZU



MJF-005

OE NO.: 8-97096777-0
Size: Φ118*125
Thread: 1 1/2- 12
Application: Isuzu Engines, Trucks

FLEETGUARD: LF3854
HENGST:
MANN: WP 1240
BALDWIN: B07159
DONALDSON: P502042



MJD-031

OE NO.: XJAF00718
Size: Φ105*153
Thread: 1"-12
Application: Case, Hitachi, Kobelco, Link-Belt, Massey Ferguson, Mitsubishi Equipment; Isuzu Engines

FLEETGUARD: LF3642
HENGST: H365W
MANN:
BALDWIN: B7144
DONALDSON: P550422



MCE-223

OE NO.: 8983129180
Size: Φ111*212
Thread: M82*1.5
Application: Isuzu

FLEETGUARD:
HENGST:
MANN:
BALDWIN:
DONALDSON:



MCC-027

OE NO.: FF5141
Size: Φ95*128
Thread: 3/4"-16
Application: Isuzu Engines

FLEETGUARD: FF5141
HENGST:
MANN:
BALDWIN: BF7559
DONALDSON:



MJC-035

OE NO.: LF3857
Size: Φ90*128
Thread: M26x1.5
Application: Isuzu, Mahindra

FLEETGUARD: LF3857
HENGST: H24W06
MANN: WP 920/80
BALDWIN:
DONALDSON:



MJF-010

OE NO.: 8-943963750
Size: Φ120*210
Thread: 1 1/2X12
Application: Isuzu

FLEETGUARD: LF3850
HENGST:
MANN:
BALDWIN: B7217
DONALDSON: P550408



MJE-030

OE NO.: 1-13240-168-1
Size: Φ108*148
Thread: 1 1/8 - 16
Application: Caterpillar, Isuzu Engines; Chevrolet, GMC, Isuzu, Iveco, Mitsubishi Trucks

FLEETGUARD: LF3328
CUMMINS: H211W
MANN:
BALDWIN: B75
DONALDSON:



MJE-031

OE NO.: 1-13240-0481
Size: Φ108*148
Thread: M20x1.5
Application: Isuzu Engines; Link-Belt Equipment

FLEETGUARD: LF3546
HENGST:
MANN:
BALDWIN: B337
DONALDSON: P551257



MHD-018

OE NO.: 1-132401940
Size: Φ95*99
Thread:
Application: Isuzu, Hino, Mitsubishi

FLEETGUARD: FF5363
HENGST:
MANN:
BALDWIN:
DONALDSON:



MHB-021

OE NO.: 9-88511191-0
Size: Φ71*105
Thread:
Application: Isuzu, Hino

FLEETGUARD: FF5029
HENGST:
MANN: P818x
BALDWIN:
DONALDSON: P550026



MCB-035

OE NO.: FF5114
Size: $\Phi 84 \times 86$
Thread: 3/4X16
Application: GMC, Isuzu Trucks; Komatsu, Link-Belt Equipment

FLEETGUARD: FF5114
HENGST: H168WK
MANN: WK815/80
BALDWIN: BF7648
DONALDSON: P550057



MJC-022

OE NO.: LF3786
Size: $\Phi 93 \times 95$
Thread: M20 X 1.5
Application: ISUZU

FLEETGUARD: LF3786
HENGST:
MANN: W 920/82
BALDWIN:
DONALDSON:



MJB-033

OE NO.: LF3708
Size: $\Phi 80 \times 100$
Thread: 3/4X16
Application: ISUZU

FLEETGUARD: LF3708
HENGST:
MANN:
BALDWIN:
DONALDSON:



MHD-004

OE NO.: 8-980370110
Size: $\Phi 99 \times 112$
Thread:
Application: Isuzu, Chevrolet

FLEETGUARD: FS36243
HENGST:
MANN:
BALDWIN:
DONALDSON: P502427



MHD-010

OE NO.: 8-98092481-1
Size: $\Phi 101 \times 193$
Thread:
Application: Isuzu

FLEETGUARD: FF5989
HENGST:
MANN:
BALDWIN:
DONALDSON: P502502



MCC-003

OE NO.: 5876101570
Size: $\Phi 98.5 \times 140$
Thread: M20*1.5
Application: Isuzu, Chevrolet, Mitsubishi

FLEETGUARD: FF5160
HENGST:
MANN:
BALDWIN: BF7534
DONALDSON: P550390



MCC-204

OE NO.: FF5160
Size: $\Phi 94 \times 139$
Thread: M20*1.5
Application: Chevrolet, Dodge, GMC, Isuzu, Mitsubishi Automotive, Light-Duty Trucks

FLEETGUARD: FF5160
HENGST: H17WK09
MANN: WK940/11x
BALDWIN: BF7534
DONALDSON: P550390



MJB-034

OE NO.: 8973587200
Size: $\Phi 80 \times 160$
Thread: M 26 X 1.5
Application: ISUZU

FLEETGUARD: LF16267
HENGST:
MANN: W8018
BALDWIN:
DONALDSON: P506008



MCC-232

OE NO.: FF5108
Size: $\Phi 94.5 \times 123$
Thread: 3/4"-16UNF2B
Application: Case, Hitachi, Kawasaki, Koehring, Link-Belt Equipment; Chevrolet, GMC, Isuzu Trucks

FLEETGUARD: FF5108
HENGST:
MANN:
BALDWIN: BF7602
DONALDSON:



MCB-188

OE NO.: 8-971 72549.1
Size: $\Phi 83 \times 77$
Thread: 3/4"-16UNF-2B
Application: ISUZU

FLEETGUARD: FF5451
HENGST:
MANN:
BALDWIN:
DONALDSON: P505951



MJB-085

OE NO.: LF16242
Size: $\Phi 77 \times 87$
Thread: M22*1.56H
Application: Chevrolet, Freightliner, Isuzu, Ram

FLEETGUARD: LF16242
HENGST:
MANN:
BALDWIN:
DONALDSON:



MCC-264

OE NO.: FS19520
Size: $\Phi 95 \times 188$
Thread: 1"-12UNS-2B
Application: Isuzu, Chevrolet, General Motors

FLEETGUARD: FS19520
HENGST:
MANN:
BALDWIN: BF1342
DONALDSON: P555020



WG-338

OE NO.: 8-98018858-0
Size: $\Phi 68 \times 156$
Thread:
Application: Isuzu Engines, Trucks

FLEETGUARD: LF17501
HENGST:
MANN:
BALDWIN:
DONALDSON:



MHB-040

OE NO.: 8-98147-525-0
Size:
Thread:
Application: ISUZU

FLEETGUARD: FF5877
HENGST:
MANN:
BALDWIN:
DONALDSON:



MHD-020

OE NO.: EF-1802
Size: $\Phi 90 \times 116$
Thread:
Application: ISUZU

FLEETGUARD: FF5732
HENGST:
MANN:
BALDWIN:
DONALDSON: P502425



MJF-096

OE NO.: 2-94654-200-0
Size: $\Phi 120 \times 125$
Thread: 1-1/2"-12UNF-2B
Application: ISUZU

FLEETGUARD: LF17537
HENGST:
MANN:
BALDWIN:
DONALDSON:



MCC-091

OE NO.: 461 6545
Size: $\Phi 94 \times 123$
Thread: 3/4"-16UNF-2B
Application: Hitachi, Isuzu

FLEETGUARD: FF5108
HENGST:
MANN:
BALDWIN: BF7602
DONALDSON:



MCB-043

OE NO.: 8-94394079-2
Size: $\Phi 83 \times 102$
Thread: 3/4"-16UNF-2B
Application: ISUZU, HINO

FLEETGUARD: FF5138
HENGST:
MANN:
BALDWIN:
DONALDSON:



MJB-072

OE NO.: 8-98165071-0
Size: $\Phi 84 \times 101$
Thread: M26*1.5-6H
Application: ISUZU

FLEETGUARD: LF16369
HENGST:
MANN:
BALDWIN:
DONALDSON:



MCB-137

OE NO.: 23303-54072
Size: $\Phi 83 \times 100$
Thread: 3/4"-16UNF-2B
Application: ISUZU, HINO, NISSAN, TOYOTA

FLEETGUARD: FF5138
HENGST: H168WK
MANN: WK815/80
BALDWIN: BF954
DONALDSON: P550057



MJC-158

OE NO.: Z164
Size: $\Phi 94.5 \times 118.5$
Thread: M20*1.5
Application: ISUZU

FLEETGUARD:
HENGST: H90W25
MANN: W815/5
BALDWIN:
DONALDSON:



MJC-058

OE NO.: 2-94561-102-1
Size: $\Phi 93 \times 154$
Thread: 3/4-16 UN
Application: Toyota, Dodge, Hino, Nissan

FLEETGUARD: LF551A
HENGST: H17W02
MANN: W 940/1
BALDWIN:
DONALDSON: P550008



MJD-028

OE NO.: C1706
Size: $\Phi 105 \times 150$
Thread: 1"-12UNF-2B
Application: ISUZU, MAZDA

FLEETGUARD: LF3665
HENGST:
MANN:
BALDWIN: B7130
DONALDSON: P550409

KOMATSU



MCC-058

OE NO.: 600311-9121
Size: $\Phi 99 \times 185$
Thread: 1-14
Application: Komatsu

FLEETGUARD: FF5076
HENGST: H19WK01
MANN: WK 950/3
BALDWIN: BF970
DONALDSON: P557440



MCB-064

OE NO.: 6732-71-6112
Size: $\Phi 77 \times 166$
Thread: M16*1.5
Application: Case, Consolidated Diesel, Cummins Engines, Komatsu Equipment

FLEETGUARD: FFS494/ FF42000/FF42001
HENGST:
MANN: WK 8003 X
BALDWIN: BF788
DONALDSON:



MCC-095

OE NO.: 600-311-8293
Size: $\Phi 95 \times 144$
Thread: 1"-14UNF
Application: Komatsu Engines, Equipment

FLEETGUARD: FF5253
HENGST: H19WK01
MANN: WK 950/3
BALDWIN: BF1248
DONALDSON:



MCB-217

OE NO.: 600-311-8220
Size: $\Phi 83 \times 142$
Thread: 3/4-16 UNF
Application: RENAULTTRUCKS, MAN, VOLVO, SCANIA, IVECO, KOMATSU

FLEETGUARD: FF5058
HENGST: H184WK
MANN: W723/1
BALDWIN: BF719
DONALDSON: P550410



MJE-040

OE NO.: 600-211-1231
Size: $\Phi 110 \times 273$
Thread: 1-1/2"-12
Application: KOMATSU Dump/Haul Trucks, HYUNDAI Excavators

FLEETGUARD: LF670
HENGST: H240W
MANN: W1294
BALDWIN: B96
DONALDSON:



MJC-096

OE NO.: 6736-51-5142
Size: $\Phi 95 \times 173$
Thread: 1"-16
Application: KOMATSU, FREIGHTLINER, JCB, HYUNDAI, VOLVO, NEW HOLLAND, DAF

FLEETGUARD: LF3713
HENGST:
MANN: W 950/41
BALDWIN: B7181
DONALDSON: P550909



MCB-109

OE NO.: 600-311-3870
Size: $\Phi 83 \times 146$
Thread: 13/16"-16
Application: KOMATSU

FLEETGUARD: FF42120
HENGST:
MANN:
BALDWIN:
DONALDSON:



MCF-005

OE NO.: 600-311-4510
Size: $\Phi 128.5 \times 251$
Thread: 1-1/4"-12
Application: Komatsu Dump Trucks, Equipment

FLEETGUARD: FS19946
HENGST:
MANN:
BALDWIN: BF12880
DONALDSON: P553200



MJF-017

OE NO.: 600-311-7132
Size: $\Phi 128 \times 297$
Thread: 1-1/4"-12UNF-28
Application: KOMATSU

FLEETGUARD: FF202
HENGST: H176WK
MANN: WK 12111
BALDWIN: BF596
DONALDSON: P550202



MJE-045

OE NO.: 600-211-1230
Size: $\Phi 107 \times 273$
Thread: 1-1/4"-12UNF-28
Application: KOMATSU

FLEETGUARD: LF747
HENGST: H240W
MANN: W 12106
BALDWIN: B196
DONALDSON:



MJF-094

OE NO.: LF9050
Size: $\Phi 118.6 \times 296$
Thread: M90*2
Application: Cummins Engines

FLEETGUARD: LF9050
Cummins: 4016657
MANN: WP 12905
BALDWIN: BD7176
DONALDSON: P554560



MJF-099

OE NO.: BD7176
Size: $\Phi 120 \times 295$
Thread: M90 x 2.0
Application: Cummins Engines

FLEETGUARD: LF9050
HENGST:
MANN: WP12905
BALDWIN: B7176
DONALDSON: P554560



MCF-011

OE NO.: FF202
Size: $\Phi 115.5 \times 286$
Thread: 1 1/4"x12
Application: KOMATSU Motor Graders

FLEETGUARD: FF202
HENGST: H176WK
MANN: WK12111
BALDWIN: BF596
DONALDSON: P550202



MSC-003

OE NO.: 600-411-1151
Size: $\Phi 95 \times 136.5$
Thread: 11/16"-16
Application: Komatsu

FLEETGUARD: WF2144/WF2053
HENGST:
MANN: WA9140
BALDWIN: BW5139
DONALDSON: P552073



MSC-005

OE NO.: 600-411-1191
Size: $\Phi 94 \times 112$
Thread: 1 1/16"-16UN
Application: Komatsu

FLEETGUARD: WF2088
HENGST: H13WF12
MANN: WA 9110
BALDWIN:
DONALDSON:



MSC-004

OE NO.: WF2075
Size: $\Phi 95 \times 136$
Thread: 11/16"-16
Application: Cummins Engines, HYUNDAI Excavators, HITACHI Loaders

FLEETGUARD: WF2075
HENGST: H32WF
MANN: WA 940/7
BALDWIN: BW5075
DONALDSON: P552075



MCF-027

OE NO.: FF63040NN
Size: $\Phi 125 \times 275$
Thread: 1 3/8"-12
Application: Komatsu

FLEETGUARD: FF63040NN
HENGST: H572WK
MANN: WK12006
BALDWIN:
DONALDSON: P502480



MJF-090

OE NO.: LF9018
Size: $\Phi 118.6 \times 330$
Thread: M95*2.5
Application: Komatsu Equipment

FLEETGUARD: LF9018
HENGST:
MANN:
BALDWIN: BD7355
DONALDSON: P559000



MCF-026

OE NO.: 3820664
Size: $\Phi 120 \times 312$
Thread: 1.1/4"-12
Application: Cummins Engines; International, Kenworth, Komatsu

FLEETGUARD: FS1216
HENGST:
MANN:
BALDWIN: BF1216
DONALDSON: P552216



MCC-046

OE NO.: FF105
Size: $\Phi 95 \times 138$
Thread: 1"-14
Application: Komatsu, Kenworth, Ford, Peterbilt

FLEETGUARD: FF105
HENGST: H177WK
MANN: WK950/3
BALDWIN: BF957B
DONALDSON: P550105



MJC-045

OE NO.: LF3345
Size: $\Phi 95 \times 137$
Thread: 1"-16
Application: Agco, Case, Dresser, Dynapac, Grove, Komatsu, MacDon, Vermeer Equipment; Cummins Engines

FLEETGUARD: LF3345
HENGST: H17W19
MANN: W94034
BALDWIN: BT427
DONALDSON: P558616



MCF-014

OE NO.: FS1006
Size: $\Phi 119 \times 322$
Thread: 1-1/4"-12UNF-28
Application: Cummins Engines

FLEETGUARD: FS1006
HENGST:
MANN: WK12290
BALDWIN: BF1262
DONALDSON:



MCC-053

OE NO.: FF5578
Size: $\Phi 95 \times 145.5$
Thread: 1-1/4" UNF-2B
Application: Komatsu

FLEETGUARD: FF5578
HENGST:
MANN: WK9150
BALDWIN:
DONALDSON:

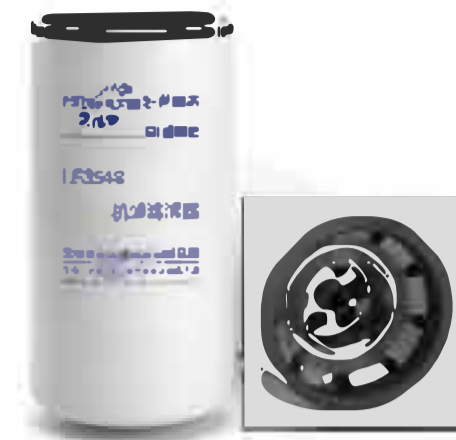

MJF-042

OE NO.: LF3548
Size: $\Phi 118 \times 241$
Thread: 2-1/4"-12
Application: Agco, Case, Fiat/Alis, Grove, Ingersoll-Rand, Komatsu, Link-Belt Equipment

FLEETGUARD: LF3548
HENGST:
MANN: WP12308
BALDWIN: 8D324
DONALDSON: P553548



MCC-176

OE NO.: FF5253
Size: $\Phi 94.5 \times 180$
Thread: 1"-14 UNF-2B
Application: Hitachi, Komatsu Equipment

FLEETGUARD: FF5253
HENGST: H19WK01
MANN: WK950/3
BALDWIN: BF7546
DONALDSON: P557440



MCC-266

OE NO.: BF1394-SP
Size: $\Phi 94 \times 255$
Thread: 1-14 UN
Application: Komatsu Equipment

FLEETGUARD: FS19770
HENGST:
MANN: WK9052x
BALDWIN:
DONALDSON: P505961



MJC-183

OE NO.: LF3415
Size: $\Phi 94.5 \times 96$
Thread: 1"-12 UNF-2B
Application: Komatsu Equipment

FLEETGUARD: LF3415
HENGST: H20W09
MANN: W93015
BALDWIN: B7220
DONALDSON: P550719



MJC-129

OE NO.: LF760
Size: $\Phi 94.5 \times 131$
Thread: 1"-12 UNF-2B
Application: Komatsu

FLEETGUARD: LF760
HENGST: H17W04
MANN: W940/18
BALDWIN:
DONALDSON: P552819



MCF-020

OE NO.: FF5611
Size: $\Phi 118.5 \times 285$
Thread: 1-5/8"-12 UN-2B
Application: Komatsu Equipment

FLEETGUARD: FF5611
HENGST:
MANN:
BALDWIN: BF7948
DONALDSON: P553500



MJC-197

OE NO.: LF3315
Size: $\Phi 94.5 \times 142.5$
Thread: M22 \times 1.5-6H
Application: Komatsu, New Holland Equipment, Onan Generators, VM Engines

FLEETGUARD: LF3315
HENGST: H17W23
MANN: W940/37
BALDWIN: B281
DONALDSON: P553315



MJF-059

OE NO.: S1560-72051
Size: $\Phi 120 \times 206$
Thread: 1-1/2"-16
Application: Hino, Nissan UD Trucks

FLEETGUARD: LF3818
HENGST:
MANN:
BALDWIN: 87155
DONALDSON: P552050



MJE-015

OE NO.: 15607-1731
Size: $\Phi 113 \times 208$
Thread: 1 1/2"-16 UNF
Application: HINO Buses

FLEETGUARD: LF3618
HENGST:
MANN:
BALDWIN: BD7105
DONALDSON: P502805



MCB-052

OE NO.: 23401-1330/1/2
Size: $\Phi 78.5 \times 100.5$
Thread: 3/4"-16 UNF
Application: HINO Buses, ISUZU Trucks, KOMATSU Excavators

FLEETGUARD: FF5138
HENGST:
MANN:
BALDWIN: BF7967
DONALDSON:



MJD-005

OE NO.: 15607-1330
Size: $\Phi 108 \times 148.5$
Thread: M26 \times 1.5
Application: Hino, Toyota

FLEETGUARD: LF3689
HENGST:
MANN:
BALDWIN: B7045
DONALDSON: P550406



MJE-083

OE NO.: 15607-1600
Size: $\Phi 112 \times 210$
Thread: 1 1/2"-16 UNF-2B
Application: Hino, Nissan Trucks; Hitachi, Kobelco Equipment

FLEETGUARD: LF3618
HENGST:
MANN:
BALDWIN: 8D7105
DONALDSON:



MCB-005

OE NO.: P550225
Size: $\Phi 83 \times 101$
Thread: 13/16" UNF
Application: HINO

FLEETGUARD: FF5138
HENGST: H17WK09
MANN: WK940/16 x
BALDWIN: BF7543
DONALDSON: P550225



MCC-282

OE NO.: FC-13210
Size: $\Phi 91.5 \times 89.6$
Thread: 1-14 UNF-2B
Application: HINO, TOYOTA

REFERENCE NO.: 23304-78420
HENGST:
MANN:
BALDWIN:
DONALDSON:



MJF-025

OE NO.: LF16110
Size: $\Phi 125 \times 210$
Thread: 1-1/2"-16
Application: HINO

FLEETGUARD: LF16110
HENGST:
MANN:
BALDWIN: B7325
DONALDSON: P502364



MCE-014

OE NO.: P550436
Size: $\Phi 111 \times 129$
Thread: 1"-14
Application: HINO

FLEETGUARD: FS19521
HENGST:
MANN:
BALDWIN: BF134B0
DONALDSON: P550436



MHB-009

OE NO.: FF5734
Size: $\Phi 86.5 \times 91$
Thread:
Application: HINO

FLEETGUARD: FF5734
HENGST:
MANN:
BALDWIN:
DONALDSON: P502530



OE NO.: 23401-1730
Size: $\Phi 95 \times 194$
Thread:
Application: Hino

FLEETGUARD: FS36212
HENGST:
MANN:
BALDWIN:
DONALDSON: P502426

MHD-014



OE NO.: 23304-78091
Size: $\Phi 87.5 \times \Phi 11.5 \times 145$
Thread:
Application: Hino

FLEETGUARD: FF5974
HENGST:
MANN:
BALDWIN:
DONALDSON:

MHC-054



OE NO.: 23304-EV470
Size: $\Phi 85 \times 123.5$
Thread:
Application: Hino

FLEETGUARD:
HENGST:
MANN:
BALDWIN:
DONALDSON:

MHC-076



OE NO.: 23304-EV430
Size: $\Phi 111.4 \times 120.5$
Thread:
Application: HINO

FLEETGUARD:
HENGST:
MANN:
BALDWIN:
DONALDSON:

MHF-065



OE NO.: 23304-EV360
Size:
Thread:
Application: HINO

FLEETGUARD: FF5973
HENGST:
MANN:
BALDWIN:
DONALDSON:

MHC-103



OE NO.: 15607-1040
Size: $\Phi 103 \times \Phi 49 \times 165$
Thread:
Application: Hino, Nissan Trucks; Isuzu Engines

FLEETGUARD: LF3319
HENGST:
MANN:
BALDWIN: P723
DONALDSON:

MHE-007



OE NO.: 23401-1690
Size: $\Phi 88 \times \Phi 19 \times 137$
Thread:
Application: Hino

FLEETGUARD: FF5733
HENGST:
MANN:
BALDWIN:
DONALDSON:

MHC-052



OE NO.: S1560-72261
Size: $\Phi 104 \times 184$
Thread:
Application: HINO

FLEETGUARD:
HENGST:
MANN:
BALDWIN:
DONALDSON:

MHE-011



OE NO.: 52340-11133
Size: $\Phi 84 \times 76$
Thread: M20*1.5
Application: Hino

FLEETGUARD: FF5147 / FF5226
HENGST: H173WK
MANN: WK812
BALDWIN: BF7683
DONALDSON: P550127

MCB-094



OE NO.: 15613-E0080
Size: $\Phi 105.5 \times 161$
Thread: 1"-12UNF-2B
Application: Hino

FLEETGUARD: LF16253
HENGST:
MANN:
BALDWIN:
DONALDSON:

MJD-042



OE NO.: 15607-1671
Size: $\Phi 112 \times 162$
Thread: 1-1/2"-12UN-2B
Application: Hino Trucks

FLEETGUARD: LF3541
HENGST:
MANN:
BALDWIN: B404
DONALDSON: P550947

MJE-120



OE NO.: PH3690
Size: $\Phi 119.5 \times 160$
Thread: 1-1/2"-12UNF-2B
Application: HINO; CATERPILLAR

FLEETGUARD: LF33335C
HENGST:
MANN:
BALDWIN: 8105
DONALDSON: P550947

MJF-064

MITSUBISHI

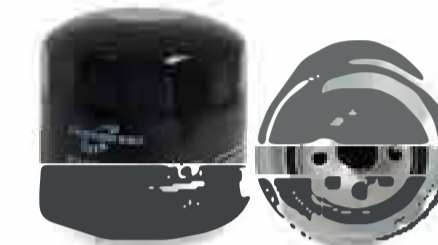

OE NO.: ME006066
Size: $\Phi 92 \times 79$
Thread: M 20 X 1.5
Application: MITSUBISHI FUSO

FLEETGUARD: FF5088/FF5087
HENGST:
MANN: WK 818/80
BALDWIN: BF7552
DONALDSON: P550048

MCC-011



OE NO.: ME014833
Size: $\Phi 105 \times 128$
Thread: M20*1.5
Application: MDI/Yutani Equipment; Mitsubishi Engines, Trucks

FLEETGUARD: LF3433
HENGST: H20W 10
MANN: W 921/80
BALDWIN: 87189
DONALDSON: P905002

MJD-013



OE NO.: ME035393
Size: $\Phi 94 \times 125$
Thread: M20*1.5
Application: Mitsubishi, Caterpillar, Kubota

FLEETGUARD: FF5089
HENGST:
MANN: WK 10 020
BALDWIN: BF7538
DONALDSON: P550048

MCC-031



OE NO.: ME013307
Size: $\Phi 104 \times 151$
Thread: M26X1.5
Application: Mitsubishi

FLEETGUARD: LF3830
HENGST: H96W 03
MANN: W P1045
BALDWIN: 807028
DONALDSON: P502008

MJD-009



OE NO.: MD013661
Size: $\Phi 85.3 \times 120$
Thread: M20 X 1.5
Application: Mitsubishi, Ford, Hino

FLEETGUARD: LF3369
HENGST: H20W05
MANN: W 816/80
BALDWIN:
DONALDSON: P550934

MJC-066



OE NO.: MD069782
Size: $\Phi 102 \times 127.5$
Thread: M26 X P1.5
Application: Mitsubishi, Ford

FLEETGUARD: LF3564
HENGST: H209W
MANN: W 9066
BALDWIN:
DONALDSON: P551343

MJD-001



OE NO.: MD135737
Size: $\Phi 68 \times 87.3$
Thread: M20*1.5
Application: Dodge, Eagle, Ford, Honda, Infiniti, Mazda, Mitsubishi, Nissan, Plymouth Automotive

FLEETGUARD: LF3537
CUMMINS: H97W05
MANN: W 610
BALDWIN: B1402
DONALDSON: P502007

MJA-001



OE NO.: ME014838
Size: $\Phi 90 \times 110$
Thread: M18 X 1.5
Application: Caterpillar, Kobelco, MDI-Yutani Excavators; Mitsubishi Engines

FLEETGUARD: LF3524
HENGST:
MANN:
BALDWIN: BT338
DONALDSON:

MJC-216



OE NO.: ME056670
Size: $\Phi 96 \times 168$
Thread: M24*1.5
Application: Mitsubishi, Tadano, Hitachi

FLEETGUARD: FF5367
CUMMINS:
MANN:
BALDWIN: BF7993
DONALDSON: P550391

MCC-068



OE NO.: FF5089
Size: $\Phi 93.5 \times 124$
Thread: M20*1.5-6H
Application: Caterpillar, Mitsubishi

FLEETGUARD: FF5089
HENGST:
MANN: WK10020
BALDWIN: BF720
DONALDSON: P552561

MCC-206



MJD-036

OE NO.: LF3830
Size: $\Phi 105 \times 150$
Thread: M26*1.5
Application: Kobelco Excavators; Mitsubishi Engines, Trucks

FLEETGUARD: LF3830
HENGST: H96W03
MANN:
BALDWIN: 8D7028
DONALDSON: P502008



MJF-011

OE NO.: LF3586
Size: $\Phi 125 \times 210$
Thread: M20 x P1.5
Application: Caterpillar Excavators, Lift Trucks; Mitsubishi Engines, Excavators, Trucks; Nissan Trucks

FLEETGUARD: LF3586
CATERPILLAR: E48H
MANN:
BALDWIN: 8D1403
DONALDSON: P550247



MHB-044

OE NO.: ML239124
Size: $\Phi 75 \times 75 \times 170$
Thread:
Application: Iveco, Mitsubishi

FLEETGUARD: FF5834
HENGST:
MANN:
BALDWIN:
DONALDSON:



MHB-045

OE NO.: QC00001
Size: $\Phi 75 \times 75 \times 140$
Thread:
Application: Mitsubishi Fuso Canter FE125, FE130, FE160, FE180, FG4x4 Trucks with (3.0L) Engines

FLEETGUARD: LF16330
HENGST: E845H D335
MANN:
BALDWIN: P40037
DONALDSON:



MHD-016

OE NO.: ME084641
Size: $\Phi 94 \times \Phi 35.2 \times 126$
Thread:
Application: Mitsubishi

FLEETGUARD: LF3815
HENGST:
MANN:
BALDWIN:
DONALDSON:



MJF-027

OE NO.: ME074013
Size: $\Phi 130 \times 220$
Thread: M36 x 1.5
Application: Caterpillar Excavators, Lift Trucks; Mitsubishi Engines, Excavators, Trucks; Nissan Trucks

FLEETGUARD: LF3586
HENGST:
MANN:
BALDWIN: 8D1403
DONALDSON:



MJD-021

OE NO.: LF17518
Size: $\Phi 103 \times 162$
Thread: M26*1.5-6H
Application: Mitsubishi

FLEETGUARD: LF17518
CUMMINS:
MANN:
BALDWIN:
DONALDSON:



MCD-005

OE NO.: FF5831
Size: $\Phi 104.5 \times 109$
Thread: M20*1.5
Application: Mitsubishi

FLEETGUARD: FF5831
HENGST:
MANN: WK 9023 z
BALDWIN:
DONALDSON:



MJB-029

OE NO.: 15400-PR3-004
Size: $\Phi 84 \times 81$
Thread: M20*1.5-6H
Application: Isuzu, Mitsubishi, Hyundai

FLEETGUARD: LF3462
CUMMINS: H13W01
MANN: W814/80
BALDWIN: 8227
DONALDSON:



MCC-130

OE NO.: 31945-41002
Size: $\Phi 93 \times 75$
Thread: M20x1.5-6H
Application: Mitsubishi

FLEETGUARD: FF5088
HENGST:
MANN:
BALDWIN:
DONALDSON:



MJB-114

OE NO.: 37563-07100
Size: $\Phi 83 \times 100$
Thread: M20*1.5-6H
Application: MITSUBISHI

FLEETGUARD:
CUMMINS:
MANN:
BALDWIN:
DONALDSON:



MJB-059

OE NO.: 26300-35500
Size: $\Phi 77 \times 87$
Thread: M20x 1.5
Application: Chrysler, Dodge, Hyundai, Kia, Mitsubishi Automotive, Light-Duty Trucks

FLEETGUARD: LF3462
HENGST: H13W01
MANN: W811/80
BALDWIN: 87243



MJD-012

OE NO.: 26300-42000
Size: $\Phi 102 \times 127.5$
Thread: M26*1.5
Application: HYUNDAI, Mitsubishi, Ford

FLEETGUARD: LF3564
HENGST: H209W
MANN: W928/83
BALDWIN: 8D28
DONALDSON:



MJC-065

OE NO.: 26300-42030
Size: $\Phi 94 \times 120$
Thread: M26*1.5
Application: Hyundai

FLEETGUARD: LF16227
HENGST: H10W19
MANN: W930/26
BALDWIN:
DONALDSON: P551343



MJC-043

OE NO.: 26300-42040
Size: $\Phi 95 \times 120$
Thread: M26*1.5
Application: HYUNDAI

FLEETGUARD: LF16227 / LF3689
HENGST: H10W19
MANN: W9020
BALDWIN:
DONALDSON: P551343



MJA-013

OE NO.: 26300-2Y500
Size: $\Phi 70 \times 90$
Thread: M20x1.5
Application: Hyundai, MAZDA, SUBARU

FLEETGUARD:
HENGST: H97W06
MANN: W67/1
BALDWIN:
DONALDSON:



MCC-017

OE NO.: 31945-44000 / 31945-44001
Size: $\Phi 98 \times 139$
Thread: M20x1.5
Application: Hyundai, Mitsubishi, KIA

FLEETGUARD:
HENGST:
MANN:
BALDWIN:
DONALDSON:



MCC-003

OE NO.: 31973-44000 / 31973-44001
Size: $\Phi 97 \times 140$
Thread: M20x1.5
Application: Hyundai, Isuzu, Mitsubishi

FLEETGUARD:
HENGST: H17WK09
MANN: WK 940/11 x
BALDWIN:
DONALDSON:



MCC-041

OE NO.: F51242
Size: $\Phi 93 \times 219$
Thread: 1-14 UN
Application: Ford, Freightliner, International Buses, Trucks; Hyundai Equipment

FLEETGUARD: F51242
HENGST:
MANN: WK 940/36x
BALDWIN: BF1249-O
DONALDSON: P553201



MJC-138

OE NO.: LF3552
Size: $\Phi 94 \times 175$
Thread: 1"-16
Application: HYUNDAI, Komatsu, Jcb, Ford

FLEETGUARD: LF3552
CUMMINS: H19W08
MANN: W950/18
BALDWIN: 8D7317
DONALDSON:



MCC-067

OE NO.: 31945-41001
Size: $\Phi 93 \times 102$
Thread: M20*1.5
Application: Hyundai

FLEETGUARD: FF5088
HENGST:
MANN: WK 818/80
BALDWIN: 8F792
DONALDSON: P550049

HYUNDAI



OE NO.: 31922-3A850
Size: Φ84*142
Thread: M16*1.5-6H
Application: Hyundai

FLEETGUARD:
HENGST: H70WK13
MANN: WK824/1
BALDWIN:
DONALDSON:

MCB-203



OE NO.: 31922 4H001
Size: Φ86*141
Thread: M16*1.5
Application: Hyundai, Kia

FLEETGUARD:
HENGST: H70WK13
MANN: WK 8019
BALDWIN:
DONALDSON:

MCB-089



OE NO.: 31955-52700
Size: Φ108*161
Thread: M24*1.5-6H
Application: Hyundai

REFERENCE NO.: SFC-28210
HENGST:
MANN:
BALDWIN:
DONALDSON: J86-22700

MCE-229



OE NO.: 31955-52910
Size: Φ112*156.4
Thread: M24*1.5-6H
Application: HYUNDAI

FLEETGUARD:
HENGST:
MANN:
BALDWIN:
DONALDSON:

MCE-181



OE NO.: 26325-52003
Size: Φ84*129
Thread:
Application: Hyundai

FLEETGUARD:
HENGST:
MANN:
BALDWIN:
DONALDSON:

WG-017



OE NO.: 26320-2F000
Size: Φ65*131
Thread:
Application: Kia, Hyundai

FLEETGUARD:
HENGST: E822HD255
MANN: HU7027z
BALDWIN:
DONALDSON:

WG-331



OE NO.: 31922-28900
Size: Φ78.5*140
Thread: M16*1.5-6H
Application: Hyundai

FLEETGUARD:
HENGST: H707WK
MANN: WK824/3
BALDWIN:
DONALDSON:

MCB-210



OE NO.: 31922-26910
Size: Φ85.5*137
Thread: M16*1.5-6H
Application: Hyundai

FLEETGUARD:
HENGST: H70WK14
MANN: WK824/2
BALDWIN:
DONALDSON: P550588

MCB-096



OE NO.: 31945-84000
Size: Φ96*168.5
Thread: M22*1.5
Application: Hyundai Excavators

FLEETGUARD:
HENGST:
MANN:
BALDWIN:
DONALDSON:

MCC-107



OE NO.: 26300-35504
Size: Φ83*76
Thread: M20*1.5-6H
Application: Chrysler, Dodge, Hyundai, Kia, Mitsubishi Automotive, Light Duty Trucks

FLEETGUARD:
HENGST:
MANN:
BALDWIN: 87243
DONALDSON:

MJB-156



OE NO.: 31945-84400
Size: Φ109*204
Thread: 15/16*-16
Application: Hyundai

FLEETGUARD:
HENGST:
MANN:
BALDWIN:
DONALDSON: P502475

MCE-101

OTHERS



OE NO.: HY349004566A/SN25159
Size: Φ122*259
Thread: M32*1.5
Application: Hidromek

FLEETGUARD:
HENGST:
MANN:
BALDWIN:
DONALDSON:

MJC-227



OE NO.: YA00037134
Size: Φ110*192
Thread: 1"-14
Application: Hitachi

FLEETGUARD:
HENGST:
MANN:
BALDWIN:
DONALDSON:

MCE-222



OE NO.: 194327-48450
Size: Φ97*178
Thread: 1-1/2*-16
Application: Yanmar

FLEETGUARD:
HENGST:
MANN:
BALDWIN:
DONALDSON:

MJC-283



OE NO.: 1117050-M50-02000
Size: Φ94.5*163
Thread: M18*1.5
Application: FAWDE

FLEETGUARD:
HENGST:
MANN:
BALDWIN:
DONALDSON:

MCC-217



OE NO.: 1105010LE6C0
Size: Φ110*238
Thread: 1"-14UNS-28
Application: JAC

FLEETGUARD: FS20217
HENGST:
MANN:
BALDWIN:
DONALDSON:

MCE-230



OE NO.: 1105030LG010
Size: Φ110*162
Thread: 1"-14UNS-28
Application: JAC

FLEETGUARD:
HENGST:
MANN:
BALDWIN:
DONALDSON:

MCE-058



OE NO.: 1105102LD300
Size: Φ97*188
Thread: M16*1.5
Application: JAC

FLEETGUARD:
CUMMINS:
MANN:
BALDWIN:
DONALDSON:

MCC-208



OE NO.: LF3720
Size: Φ94*137
Thread: M24x2-6H
Application: Dongfeng, King Long

FLEETGUARD: LF3720
HENGST:
MANN:
BALDWIN:
DONALDSON:

MJC-015



OE NO.: FS19816
Size: Φ121.5X290
Thread: 1"-14UNS
Application: DONGFENG TIANLONG, ISDe

FLEETGUARD: FS19816
CUMMINS:
MANN:
BALDWIN: 8F9818
DONALDSON:

MCF-001-200



OE NO.: LF17356
Size: Φ102*160
Thread:
Application: Cummins Engines, Ford, Foton

FLEETGUARD: LF17356
HENGST:
MANN:
BALDWIN:
DONALDSON:

MJD-015



OE NO.: 1174421
Size: $\Phi 94 \times 210$
Thread: 1-12 UN
Application: DEUTZ-FAHR

FLEETGUARD: LF4054/LF3687
HENGST:
MANN: W962
BALDWIN:
DONALDSON: P553771

MJC-032



OE NO.: 51.12503-0037
Size: $\Phi 78 \times 228.5$
Thread:
Application: NEOPLAN; MAN

FLEETGUARD: FF5481
HENGST: E56KP D72
MANN: PU855 x
BALDWIN: PF7878
DONALDSON: P550627

MHC-020



OE NO.: LF16352
Size: $\Phi 101 \times 174$
Thread: M27x2
Application: Cummins Engines,
Volkswagen, Foton

FLEETGUARD: LF16352
HENGST:
MANN:
BALDWIN:
DONALDSON:

MJC-227



OE NO.: FF5706
Size: $\Phi 101 \times 212$
Thread: M100x4
Application: Cummins Engines,
Volkswagen, Foton

FLEETGUARD: FF5706
HENGST:
MANN:
BALDWIN:
DONALDSON:

MCD-003



OE NO.: LF3506
Size: 109*179
Thread: M30*2
Application: M.A.N. Trucks

FLEETGUARD: LF3506
HENGST: H210W01
MANN: W1160
BALDWIN: B7116
DONALDSON: P550945

MJE-050



OE NO.: PL270
Size: $\Phi 110 \times 151$
Thread: 1"-14UNS
Application: KAMAZ; MAN

FLEETGUARD: FS19907
HENGST: H304WK
MANN: PL270 x
BALDWIN:
DONALDSON:

MCE-016



OE NO.: LF16016
Size: $\Phi 93 \times 174$
Thread: 1-16
Application: Foton Cummins

FLEETGUARD: LF16016
HENGST:
MANN:
BALDWIN:
DONALDSON:

MJC-298



OE NO.: 68197867A8
Size: $\Phi 108 \times 140$
Thread: 1-14
Application: Ram - 5500, 4500

FLEETGUARD: FS20089
HENGST:
MANN:
BALDWIN: 8F46031
DONALDSON:

MCE-183



OE NO.: 17321-32430
Size: $\Phi 93 \times 86$
Thread: 3/4-16 UN
Application: Case, Hitachi, Kubota
Equipment

FLEETGUARD: LF3682/LF3706
HENGST: H10W11
MANN:
BALDWIN: B7152
DONALDSON: P550939

MJC-275



OE NO.: 1J800-43170
Size: $\Phi 93.5 \times 100$
Thread: M20 x 1.5
Application: Haulotte - HA 26 RTJ PRO;
Kubota

FLEETGUARD: FF42110
HENGST:
MANN:
BALDWIN:
DONALDSON: P550049

MCC-160



OE NO.: 68157291AA
Size: $\Phi 108 \times 135$
Thread:
Application: RAM 2500, 3500 Light Duty
Trucks, 2013-18 RAM 4500 5500
Medium Duty Trucks w/6.7L Eng.

FLEETGUARD: FS53000
HENGST:
MANN:
BALDWIN: PF46108
DONALDSON:

MHE-018



OE NO.: LF9025
Size: $\Phi 145 \times 293$
Thread: M95*2.0
Application: International Engines;
Trucks

FLEETGUARD: LF9025
HENGST:
MANN:
BALDWIN: 8D7250
DONALDSON: P552025

MJF-091



OE NO.: CX1011A
Size: $\Phi 110 \times 166.5$
Thread: 1"-14
Application: YUCHAIYC6112,
CHENGLONG

FLEETGUARD: FS19686
HENGST:
MANN:
BALDWIN:
DONALDSON:

MCE-003



OE NO.: 8F1345
Size: $\Phi 110 \times 166.5$
Thread: 1"-14UNS-28
Application: International Engines

FLEETGUARD: FS19931
HENGST:
MANN:
BALDWIN: 8F1345
DONALDSON: P551033

MCE-243



OE NO.: 837079726
Size: $\Phi 99 \times 188$
Thread:
Application: Agco

FLEETGUARD:
HENGST:
MANN:
BALDWIN:
DONALDSON:

MCB-248



OE NO.: 837079727
Size: $\Phi 99.5 \times 172$
Thread: TR93x3
Application: Agco

FLEETGUARD:
HENGST:
MANN:
BALDWIN:
DONALDSON:

MCB-245



OE NO.: 400508-00062
Size: $\Phi 110 \times 147$
Thread: M24*1.5
Application: Doosan

FLEETGUARD:
HENGST:
MANN:
BALDWIN:
DONALDSON:

MCE-240



OE NO.: 400508-00063
Size: $\Phi 110 \times 202$
Thread: M24*1.5
Application: Doosan

FLEETGUARD:
HENGST:
MANN:
BALDWIN:
DONALDSON:

MCE-241



OE NO.: PF46126
Size: $\Phi 90 \times 106$
Thread:
Application: 2017-18 Chevrolet GMC
Light Duty Trucks

FLEETGUARD: FF5995
HENGST:
MANN:
BALDWIN: PF46126
DONALDSON:

MHC-072



OE NO.: 8F46062
Size: $\Phi 102.4 \times 162$
Thread: 3 3/8 - 8
Application: 2012-16 Chevrolet Express
Vans, GMC Savana Vans; 2001-16
Silverado Pickups, GMC Sierra Pickups;

FLEETGUARD: FS20002
HENGST:
MANN:
BALDWIN: 8F46062
DONALDSON:

MCE-182



OE NO.: FS19548
Size: $\Phi 110 \times 174$
Thread: 1"-14UNS-28
Application: International Engines

FLEETGUARD: FS19548
HENGST:
MANN:
BALDWIN: 8F1345
DONALDSON: P551033

MCE-211



OE NO.: LF9035
Size: $\Phi 118.6 \times 265$
Thread: M92*2-6H
Application: International

FLEETGUARD: LF9035
HENGST:
MANN:
BALDWIN:
DONALDSON:

MJF-076



OE NO.: LF3325
Size: $\Phi 118 \times 286$
Thread: 1" 1/2-12
Application: Cummins 16 Cylinder
Engines

FLEETGUARD: LF3325
HENGST:
MANN: W1294
BALDWIN:
DONALDSON: 87396

MJF-013



OE NO.: FF2203
Size: $\Phi 93 \times 136$
Thread: 1-14
Application: International, Kenworth,
Peterbilt Trucks with ISX Engine

FLEETGUARD: FF2203
HENGST:
MANN:
BALDWIN: 8F7760
DONALDSON: P552203

MCC-040



OE NO.: FF5644
Size: Φ119*267
Thread: 2-1/4"-12UN-2B
Application: Cummins QSK 19 (Tier3) Engine

FLEETGUARD: FF5644
HENGST:
MANN: WK12010
BALDWIN: BF7932
DONALDSON:

MCF-013



OE NO.: FF256
Size: Φ137*312
Thread: M110*2.5-7H
Application: Cummins

FLEETGUARD: FF256
HENGST:
MANN:
BALDWIN: BF46256
DONALDSON:

MCG-010



OE NO.: 53227
Size: Φ95*102
Thread: 1"-14
Application: Marine Outboard

FLEETGUARD:
HENGST:
MANN:
BALDWIN: BF46028-O
DONALDSON:

MCC-281



OE NO.: W1374/11
Size: Φ136.5*188
Thread: 1-1/2" -16UN-2B
Application: BELARUS TRACTORS

FLEETGUARD:
HENGST:
MANN: W1374/11
BALDWIN:
DONALDSON:

MJG-025



OE NO.: 6667352
Size: Φ78.5*103
Thread: M16*1.56H
Application: Bobcat Loaders; Cummins Engines; Gehl Equipment

FLEETGUARD:
HENGST:
MANN: WK715/1
BALDWIN: BF1257
DONALDSON:

MCB-235



OE NO.: PS10606
Size: Φ97.5*221
Thread: 1"-14UNS-2B
Application: Volkswagen, Agrale

FLEETGUARD: FS1105
HENGST:
MANN: WK 950/14
BALDWIN:
DONALDSON:

MCC-248



OE NO.: 1008083395
Size: Φ137*243
Thread: 1 3/8-16UN-2B
Application: Weichai Baldwin

FLEETGUARD:
HENGST:
MANN:
BALDWIN:
DONALDSON:

MCG-011



OE NO.: FS19931
Size: Φ109*171
Thread: 1"-14UNS-2B
Application: International Engines

FLEETGUARD: FS19931
HENGST:
MANN:
BALDWIN: BF1345
DONALDSON: P551034

MCE-227



OE NO.: FF5856
Size: Φ110*185
Thread: 1"-14UNS-2B
Application: Liebherr

FLEETGUARD: FF5856
HENGST:
MANN:
BALDWIN:
DONALDSON: P956054

MCE-215



OE NO.: BF7571
Size: Φ129*271
Thread: 1/2"-16UN-2B
Application: Fuel Dispensing Pumps

FLEETGUARD: FF5450
HENGST:
MANN:
BALDWIN: BF7571
DONALDSON:

MCF-023



OE NO.: CS41018
Size:
Thread:
Application: Cummins

FLEETGUARD: CS41018
HENGST:
MANN:
BALDWIN:
DONALDSON:

MJL-001



OE NO.: W719/5
Size: Φ78.5*120
Thread: 3/4"-16UNF-2B
Application: Audi, BMW, Dodge, Porsche Volkswagen Automotive; Bobcat, Deutz, Vermeer Equipment

FLEETGUARD: LF3568
HENGST: H14W04
MANN: W719/5
BALDWIN: B178
DONALDSON: P554770

MJB-048



OE NO.: K37-1021
Size: Φ104.5*Φ21*275
Thread:
Application: Kenworth, Peterbilt Trucks w/Cummins Eng.

FLEETGUARD: FS20207
HENGST:
MANN:
BALDWIN: PF46236
DONALDSON:

MHE-037



OE NO.: FS36401
Size: Φ105*190
Thread:
Application: Kenworth, Peterbilt Trucks with Cummins ISL, ISX, Paccar MX, MX-13 Engines

FLEETGUARD: FS36401
HENGST:
MANN:
BALDWIN: PF9928
DONALDSON:

MHE-047



OE NO.: C-6102
Size: Φ114*228
Thread: 1-1/8"-16UN-2B
Application: Nissan Engines, Trucks

FLEETGUARD:
HENGST:
MANN:
BALDWIN: B45
DONALDSON: P550073

MJE-165



OE NO.: 5264870
Size: Φ81*Φ30*128
Thread:
Application: CUMMINS ISF 2.8

FLEETGUARD: FS19925
HENGST:
MANN:
BALDWIN:
DONALDSON:

MHC-059



OE NO.: 51.05504-0107
Size: Φ121*205
Thread:
Application: SINOTRUK Man Engine T7

FLEETGUARD:
HENGST: E422KPD86
MANN: HU13125/3X
BALDWIN:
DONALDSON:

MCE-240



OE NO.: 2272926
Size1: Φ92.3*263
Size2: Φ92.3*190.8
Application: 2023-24 Kenworth and Peterbilt Trucks with MX11, MX13 Engines

REFERENCE NO.: 2323323&2242964
HENGST:
MANN:
BALDWIN: PF46270 KIT
DONALDSON: P583557

MHD-052 & MHD-053



OE NO.: P550821
Size: Φ95*184
Thread:
Application: International Engines, Trucks

FLEETGUARD:
HENGST: E422KPO2 D168
MANN:
BALDWIN: PF7986
DONALDSON: P550821

MHD-030



OE NO.: 0K87A14317
Size: Φ109*210
Thread: M38*1.36H
Application: KIA

FLEETGUARD:
HENGST:
MANN:
BALDWIN:
DONALDSON:

MJE-079



OE NO.: EF65030
Size:
Thread:
Application: CHEVROLET

REFERENCE NO.: 94771044
HENGST:
MANN:
BALDWIN:
DONALDSON:

MHA-073



OE NO.: 51018046002
Size:
Thread:
Application: MAN

FLEETGUARD:
HENGST:
MANN:
BALDWIN:
DONALDSON:

WG-370



OE NO.: W1323
Size: Φ136*82
Thread: 1 1/2"-16 UN
Application: Volkswagen, Nissan, Chevrolet

FLEETGUARD:
HENGST: H300W09
MANN: W1323
BALDWIN:
DONALDSON:

MJG-023



OE NO.: W9501-85030
Size: Φ96.5*179
Thread: 1-1/8"-16UN-2B
Application: Kubota

FLEETGUARD:
HENGST:
MANN:
BALDWIN:
DONALDSON:

MJC-107



MJE-131

OE NO.: 53411012075
Size: $\Phi 110 \times 189$
Thread: 1-1/8"-16UN-2B
Application: YAMZ

FLEETGUARD:
HENGST:
MANN: W1150/9
BALDWIN:
DONALDSON:



WG-225

OE NO.: HU6015Z KIT
Size: $\Phi 53 \times 125$
Thread:
Application: BMW

FLEETGUARD:
HENGST:
MANN: HU6015Z KIT
BALDWIN:
DONALDSON:



WG-212

OE NO.: 23300-75140
Size:
Thread:
Application: Toyota

FLEETGUARD: FF5766
HENGST:
MANN:
BALDWIN:
DONALDSON:



MCC-186

OE NO.: VG1540080310
Size: $\Phi 94.5 \times 138$
Thread: M18 \times 1.5
Application: SINOTRUCK

FLEETGUARD: FF5737
HENGST:
MANN:
BALDWIN:
DONALDSON:



MCC-251

OE NO.: RF500M
Size: $\Phi 95 \times 172$
Thread: 1"-14UN-28
Application: Mercury Racing

FLEETGUARD:
HENGST:
MANN:
BALDWIN:
DONALDSON:



MJB-031

OE NO.: PH3614
Size: $\Phi 78.5 \times 86$
Thread: 3/4"-16UNF-28
Application: Toyota

FLEETGUARD: LF3335
HENGST: H14W32
MANN: W712/83
BALDWIN: BT223
DONALDSON: P550939



MHF-030

OE NO.: LF3867
Size: $\Phi 121 \times \Phi 51 \times 151$
Thread:
Application: M.A.N. Engines, Trucks

FLEETGUARD: LF3867
HENGST: E13H D47
MANN: HU1381x
BALDWIN: P7190
DONALDSON: P550765

HYDRAULIC FILTER



MJC-301

OE NO.: 332202A1
Size: $\Phi 97 \times 201$
Thread: M24 \times 1.5-6g
Application: John Deere Equipment

FLEETGUARD: HF35498
HENGST:
MANN:
BALDWIN: BT9422
DONALDSON: P764729



MJC-304

OE NO.: HF6317
Size: $\Phi 96.5 \times 226$
Thread: M24 \times 1.5-6g
Application: Case, John Deere, Moxy Equipment

FLEETGUARD: HF6317
HENGST: H1 8WD03 /H18WD05
MANN: WD962/19 /WD962/9
BALDWIN: BT739
DONALDSON:



MJC-300

OE NO.: 254686A1
Size: $\Phi 97 \times 153$
Thread: 13/16-16UN-28
Application: Case, Komatsu, Volvo Loaders

FLEETGUARD: HF35150
HENGST: HY351W
MANN: WH 10 004
BALDWIN: BT8439-MPG
DONALDSON: P179342



MJB-163

OE NO.: 181167A1
Size: $\Phi 79 \times 141$
Thread: 13/16-16UN-28
Application: Caterpillar, Manitou, New Holland Equipment

FLEETGUARD: HF35467
HENGST: HG353WD
MANN: WD 724/5
BALDWIN: BT8417
DONALDSON: P550486



MJF-097

OE NO.: 86989733
Size: $\Phi 120 \times 292.5$
Thread: 1-3/8"-12
Application: Caterpillar Equipment

FLEETGUARD: HF35305
HENGST: H304W
MANN: WH 1263
BALDWIN: BT8432-MPG
DONALDSON: P179343



MJC-177

OE NO.: 84074777
Size: $\Phi 96 \times 243$
Thread: 1-3/8"-12
Application: JOHN DEERE, NEW HOLLAND, Volvo, Caterpillar

FLEETGUARD: HF6553
HENGST: H18W11
MANN: WH 980/3
BALDWIN: BT8851-MPG
DONALDSON: P164378



MJF-073

OE NO.: HF6588
Size: $\Phi 120 \times 292.5$
Thread: 1-3/4"-16UN-28
Application: Caterpillar, Champion Equipment

FLEETGUARD: HF6588
HENGST: H307W
MANN: WH 1257/1
BALDWIN: BT8878-MPG
DONALDSON: P165675



MJC-125

OE NO.: 31E9-0126-A
Size: $\Phi 94.5 \times 138$
Thread: 1-1/8"-16UN-28
Application: Hyundai

FLEETGUARD: HF28850
HENGST:
MANN:
BALDWIN:
DONALDSON: J86-30941



MJC-169

OE NO.: 2002705
Size: $\Phi 97 \times 108$
Thread: M23 \times 1.5-6H
Application: SCANIA

FLEETGUARD: HF7535
HENGST:
MANN:
BALDWIN: BT9318
DONALDSON: P761108



MCC-279

OE NO.: 70016
Size: $\Phi 97 \times 142$
Thread: 1.1/2"-16
Application: Case IH, Dresser

FLEETGUARD: HF6117
HENGST:
MANN:
BALDWIN:
DONALDSON: P566922



MJD-010

OE NO.: 82005016
Size: $\Phi 138 \times 245$
Thread: 1-3/4"-16
Application: New Holland, Ford

FLEETGUARD: HF28885
HENGST:
MANN:
BALDWIN: BT8382
DONALDSON: P502224



MJC-061

OE NO.: WD 962
Size: $\Phi 93 \times 212$
Thread: 1" -12UNF
Application: DEUTZ, RENAULTTRUCKS, KOMATSU, VOLVO

FLEETGUARD: HF28806
HENGST: H18WD01
MANN: WD 962
BALDWIN: BT735
DONALDSON: P550230



MJC-135

OE NO.: HF6057
Size: $\Phi 93 \times 136$
Thread: 1-12 UN
Application: Bobcat, Ford, Toro, Vermeer, Versatile Equipment

FLEETGUARD: HF6057
HENGST: H17WD02
MANN: WD 940/2
BALDWIN: BT839
DONALDSON: P551553

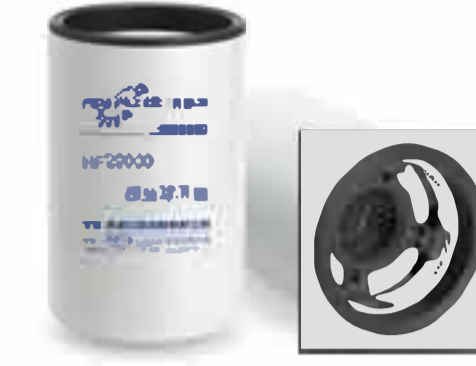

MJF-093

OE NO.: HF29000
Size: $\Phi 120 \times 195$
Thread: M90 x 2.0
Application: New Holland, Versatile Tractors

FLEETGUARD: HF29000
HENGST:
MANN:
BALDWIN: BT8503-MPG
DONALDSON:



MJE-014

OE NO.: 84160465
Size: $\Phi 108 \times 190$
Thread: 1 1/8"-16 UN
Application: NEW HOLLAND Series 90

FLEETGUARD: HF7569
HENGST: H211W
MANN: W 1150/2
BALDWIN: BT470
DONALDSON:



MJC-113

OE NO.: WD950/2
Size: $\Phi 93 \times 173$
Thread: 1-12UNF
Application: Claas, Hamm, Liebherr Equipment

FLEETGUARD: HF28989
HENGST: H19WD02
MANN: WD 950/2
BALDWIN: BT8512
DONALDSON:



MJF-020

OE NO.: HF35518
Size: $\Phi 120 \times 262$
Thread: 1-3/4"-16
Application: Ford, New Holland Tractors

FLEETGUARD: HF35518
HENGST:
MANN:
BALDWIN: BT9439
DONALDSON:

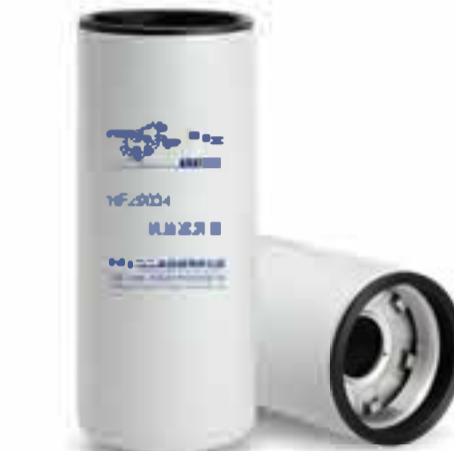

MJF-089

OE NO.: HF29034
Size: $\Phi 118.6 \times 300$
Thread: M90*2
Application: Hitachi, John Deere Loaders

FLEETGUARD: HF29034
HENGST:
MANN:
BALDWIN: BT9347-MPG
DONALDSON: P574055



MJF-052

OE NO.: 4196035152
Size: $\Phi 129.4 \times 279.4$
Thread: M120 x 2.0
Application: Komatsu Wheel Loaders

FLEETGUARD: HF29164
HENGST:
MANN:
BALDWIN: BT9360
DONALDSON:



MJF-087

OE NO.: 84196445
Size: $\Phi 115 \times 295$
Thread: M87*2.5
Application: Case, New Holland Agricultural Machinery

FLEETGUARD:
HENGST:
MANN:
BALDWIN:
DONALDSON: P569211



MJC-278

OE NO.: HF6316
Size: $\Phi 96 \times 163.5$
Thread: M24*1.5
Application: John Deere Equipment

FLEETGUARD: HF6316
HENGST: H17WD03
MANN: WD 940/4
BALDWIN: BT8415
DONALDSON:



MJC-227

OE NO.: 6661248
Size: $\Phi 97 \times 155$
Thread: 1 3/8"-12
Application: Bobcat, Case, Caterpillar, Ingram, John Deere, Vermeer Equipment

FLEETGUARD: HF6552/HF6550
HENGST:
MANN:
BALDWIN: BT8840
DONALDSON: P164375



MJF-075

OE NO.: HF6700
Size: $\Phi 128 \times 169$
Thread: 1 1/2"-16 UN-2B
Application: Bobcat, Case, Caterpillar, Ford, Hydra-Mac, International, John Deere, Owatonna, Steiger

FLEETGUARD: HF6710/HF6700
HENGST:
MANN: W1237X
BALDWIN: BT28710
DONALDSON: P560653



MJG-009

OE NO.: 84257511
Size: $\Phi 138 \times 175$
Thread: 1 3/4"-16 UNF
Application: New Holland Tractors

FLEETGUARD: HF29117
HENGST:
MANN:
BALDWIN: BT8899
DONALDSON: P765662

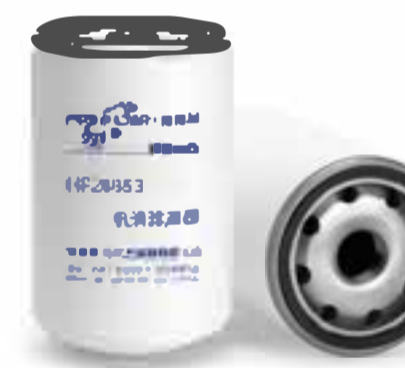

MJB-157

OE NO.: 9968353
Size: $\Phi 78.5 \times 138$
Thread: 1 3/16"-16UN-2B
Application: Caterpillar, Manitou New Holland Equipment

FLEETGUARD: HF28853
HENGST:
MANN: W 724/5
BALDWIN: BT8417
DONALDSON: P550486



MJC-215

OE NO.: KNJ0288
Size: $\Phi 95.5 \times 138$
Thread: 1-1/8"-16UN-2B
Application: Case, Hyundai, JCB, Link-Belt, Volvo Equipment

FLEETGUARD: HF7551
HENGST:
MANN: W 935/1
BALDWIN: BT334
DONALDSON:



MHG-003

OE NO.: HY13054
Size:
Thread:
Application:

FLEETGUARD:
HENGST:
MANN:
BALDWIN:
DONALDSON:



MHH-008

OE NO.: HY13558V
Size:
Thread:
Application:

FLEETGUARD:
HENGST:
MANN:
BALDWIN:
DONALDSON:



MJC-122

OE NO.: 83912256
Size: $\Phi 96 \times 167$
Thread: 1 1/8"-16
Application: New Holland, Ford

FLEETGUARD: HF6115
HENGST: H27W01
MANN:
BALDWIN:
DONALDSON:



MJF-008

OE NO.: HF6326
Size: $\Phi 130 \times 182$
Thread:
Application: Jcb, Manitou

FLEETGUARD: HF6326
HENGST:
MANN:
BALDWIN:
DONALDSON:



MJC-254

OE NO.: HHTA-59900
Size: $\Phi 95 \times 146$
Thread: 1, 1/8"-16UN-2B
Application: Kubota

FLEETGUARD: HF29156
HENGST:
MANN:
BALDWIN:
DONALDSON:

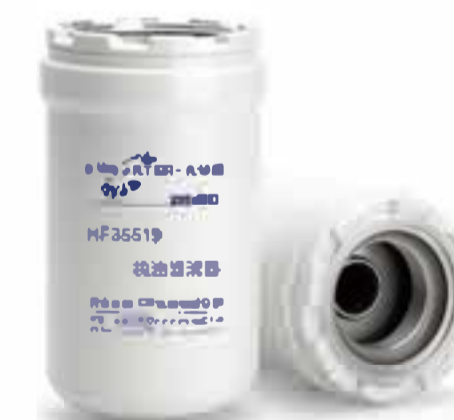

MJC-294

OE NO.: HF35519
Size: $\Phi 88.5 \times 157$
Thread:
Application: Caterpillar Equipment

FLEETGUARD: HF35519
HENGST:
MANN:
BALDWIN: BT9464
DONALDSON: P573481



MJD-020

OE NO.: 714-0728712
Size: $\Phi 106 \times 260$
Thread: M60X2
Application: Komatsu Equipment

FLEETGUARD: HF29076
HENGST:
MANN:
BALDWIN: BT9454
DONALDSON: P502577



MJB-165

OE NO.: 4630525
Size: $\Phi 88.5 \times 165$
Thread: M68X2-6H
Application: Hitachi Excavators, John Deere Excavators

FLEETGUARD: HF35516
HENGST:
MANN:
BALDWIN: BT9440
DONALDSON:



MJC-085

OE NO.: 581/18063
Size: $\Phi 93 \times 94$
Thread: 1"-12UNF
Application: JCB
FLEETGUARD: HF35139
HENGST:
MANN: WD 920/3
BALDWIN: BT9561
DONALDSON: P552819



MHD-001

OE NO.: 1R-0719
Size: $\Phi 100 \times 233$
Thread:
Application: Caterpillar
FLEETGUARD: HF35539
HENGST: E49H
MANN: H1074
BALDWIN:
DONALDSON: P569211



MHH-001

OE NO.: 1R-0732
Size: $\Phi 173 \times 229$
Thread:
Application: Caterpillar Equipment,
3408TA Engine
FLEETGUARD: HF6339
CUMMINS: E54H
MANN:
BALDWIN: PT98-10
DONALDSON: P168106



MHG-002

OE NO.: 1R-0741
Size: $\Phi 129 \times 229$
Thread:
Application: CATERPILLAR Compactors,
Dozers
FLEETGUARD: HF6098
HENGST:
MANN: H 1497/1
BALDWIN: PT9010
DONALDSON: P164205



MHG-003

OE NO.: HF6202
Size: $\Phi 129 \times 280$
Thread:
Application: Caterpillar
FLEETGUARD: HF6202
HENGST: E48H
MANN: HD1383
BALDWIN:
DONALDSON: P550709



MHA-011

OE NO.: 85108176
Size: $\Phi 64.5 \times 149$
Thread:
Application: VOLVO FH 12, IVECO Stralis
FLEETGUARD: HF35361
HENGST: E28H D174
MANN: HU 721 x KIT
BALDWIN: PT9417
DONALDSON: P550633



WG-353

OE NO.: H929/3
Size: $\Phi 83 \times 107$
Thread:
Application: SCANIA
FLEETGUARD: HF28917
HENGST: E41H
MANN: H929/3
BALDWIN:
DONALDSON: P550220



MHA-050

OE NO.: 1418
Size: $\Phi 63 \times \Phi 27.5 \times 90$
Thread:
Application: Case, Caterpillar
Equipment; International Trucks
FLEETGUARD: HF6007
HENGST:
MANN:
BALDWIN: P446
DONALDSON:



MHA-029

OE NO.: H601/4
Size: $\Phi 59 \times 101$
Thread:
Application: DAF, Iveco, M.A.N.,
Mercedes-Benz, R.V.I. Trucks
FLEETGUARD: HF6162
HENGST: E10H02
MANN: H601/4
BALDWIN: P106-HD
DONALDSON: P779625



MHA-071

OE NO.: 31E3-0018A
Size: $\Phi 43 \times 88$
Thread:
Application: Bobcat, Case, Daewoo,
Hitachi, Hyundai, Volvo Equipment
FLEETGUARD: HF28836
HENGST:
MANN:
BALDWIN: PT8392
DONALDSON: P550576



MHA-046

OE NO.: H623
Size: $\Phi 60 \times 150$
Thread:
Application: Volvo, Man, Mercedes-Benz,
Iveco
FLEETGUARD: HF35489
HENGST: E70H
MANN: H623
BALDWIN:
DONALDSON:



MHF-068

OE NO.: C1671
Size: $\Phi 114 \times \Phi 48 \times 180$
Thread:
Application: Case IH, Massey Ferguson,
Subaru, New Holland
FLEETGUARD: HF6059
HENGST:
MANN: H 1281
BALDWIN:
DONALDSON:



MHH-003

OE NO.: 1262081
Size: $\Phi 142 \times 426.5$
Thread:
Application: Caterpillar Equipment
FLEETGUARD: HF35195
HENGST: EY893H $\Phi 395$
MANN: HD 14 161
BALDWIN: PT8436
DONALDSON: P550577



MHH-004

OE NO.: 1R1809
Size: $\Phi 121.5 \times 267$
Thread:
Application: Caterpillar Equipment,
Off-Highway Trucks
FLEETGUARD: HF35480
HENGST: EY892H D393
MANN:
BALDWIN: PT9407-MPG
DONALDSON: P569614



MHH-005

OE NO.: 1799806
Size: $\Phi 140 \times 426.5$
Thread:
Application: Caterpillar Equipment
FLEETGUARD: HF35440
HENGST: EY895H
MANN: HD 15006
BALDWIN: PT9556-MPG
DONALDSON: P571271



MHH-006

OE NO.: 4J0816
Size: $\Phi 79 \times 228.5$
Thread:
Application: Caterpillar Equipment
FLEETGUARD: HF6201
HENGST: E77H
MANN: H837
BALDWIN: PT93
DONALDSON: P550816



MHF-078

OE NO.: 3621163
Size: $\Phi 121 \times 296$
Thread:
Application: Caterpillar Equipment
FLEETGUARD:
HENGST:
MANN:
BALDWIN:
DONALDSON:



MJC-307

OE NO.: 84162483
Size: $\Phi 94 \times 240$
Thread: M87 x 2.5
Application: JOHN DEERE, New Holland,
Case IH
FLEETGUARD: HF9500
HENGST:
MANN:
BALDWIN:
DONALDSON: P569206



MYH-001

OE NO.: 53C1482
Size:
Thread:
Application: LiuGong
FLEETGUARD:
HENGST:
MANN:
BALDWIN:
DONALDSON:



MYH-002

OE NO.: 53C1484
Size:
Thread:
Application: LiuGong
FLEETGUARD:
HENGST:
MANN:
BALDWIN:
DONALDSON:



MYH-005

OE NO.: 53C1693
Size:
Thread:
Application: LiuGong
FLEETGUARD:
HENGST:
MANN:
BALDWIN:
DONALDSON:



MYH-004

OE NO.: 151503000090
Size:
Thread:
Application: Sany
FLEETGUARD:
HENGST:
MANN:
BALDWIN:
DONALDSON:

AIR DRYER CARTRIDGE



MGZ-012

OE NO.: Ba5377
Size: $\Phi 148 \times 272$
Thread:
Application: Blue Bird, Thomas Buses; Freightliner, IHC, Kenworth, Mack, Peterbilt, Sterling, Western Star Trucks

FLEETGUARD:
HENGST:
MANN:
BALDWIN: Ba5377
DONALDSON:



MGZ-030

OE NO.: 432 901 228 2
Size: $\Phi 140 \times 179$
Thread: G 1 1/4
Application: Scania

FLEETGUARD: AD27749
HENGST:
MANN: TB 1394/3 x
BALDWIN:
DONALDSON: P951419



MGZ-034

OE NO.: LB11102/2
Size: $\Phi 110 \times 260$
Thread: M39*1.5-6H
Application: Irmir & Elze Ceccato

FLEETGUARD: AS2453
CUMMINS:
MANN: LB11102/2
BALDWIN: AS99028
DONALDSON:



MGZ-033

OE NO.: LB1374/2
Size: $\Phi 140 \times 177$
Thread: M39*1.5-6H
Application: Compair, Demag

FLEETGUARD: AS2452
HENGST:
MANN: LB1374/2
BALDWIN:
DONALDSON: P783184



MGZ-026

OE NO.: 4329012512
Size: $\Phi 140 \times 166$
Thread: M 41X2
Application: Evolus

FLEETGUARD: AD27755
CUMMINS:
MANN:
BALDWIN:
DONALDSON:



MGZ-028

OE NO.: C108898
Size: $\Phi 76 \times 127$
Thread: M22*1.5
Application: Screw compressors for commercial and rail vehicles

FLEETGUARD: AS 2450
HENGST:
MANN: LB 719/2
BALDWIN:
DONALDSON: P783486



MGZ-008

OE NO.: 4324100202
Size: $\Phi 144 \times 167$
Thread: M39*1.5
Application: DAF, RENAULT TRUCKS, Mercedes-Benz, FORD, MAN, IVECO

FLEETGUARD: AF27817
HENGST: T250W
MANN: TB 1374x
BALDWIN: BA5374
DONALDSON: P781466



MGZ-010

OE NO.: T300W
Size: $\Phi 144 \times 181$
Thread: G1-1/4
Application: RENAULT TRUCKS; SCANIA

FLEETGUARD: AD27745
HENGST: T300W
MANN: TB 1374/3x
BALDWIN: BA5375
DONALDSON: P783753



MGZ-014

OE NO.: BA5373
Size: $\Phi 213 \times 191$
Thread: 1.1/4"-7UNC-2B
Application: Ford, Freightliner, Hino, Kenworth, Peterbilt Trucks

FLEETGUARD:
HENGST:
MANN:
BALDWIN: BA5373
DONALDSON:



MGZ-011

OE NO.: 59553-75000
Size: $\Phi 144 \times 166$
Thread: M39*1.5-6H
Application: HYUNDAI

FLEETGUARD:
HENGST:
MANN:
BALDWIN:
DONALDSON:



MGZ-006

OE NO.: T280W
Size: $\Phi 136 \times 167$
Thread: M39x15
Application: Mack, DAF, MAN, BENZ, Renault

FLEETGUARD: AD27747
HENGST: T280W
MANN: TB1394/1X
BALDWIN: BA5592
DONALDSON: P951413



MGZ-024

OE NO.: 20773824
Size: $\Phi 148 \times 168$
Thread:
Application: Volvo

FLEETGUARD:
HENGST: T350W
MANN:
BALDWIN:
DONALDSON: T350W



WG-126

OE NO.: 22223804
Size: $\Phi 155 \times 160$
Thread:
Application: Volvo

FLEETGUARD:
HENGST: T370W
MANN:
BALDWIN:
DONALDSON:



MGZ-023

OE NO.: 1527755
Size: $\Phi 144 \times 166$
Thread: M41*1.5-6H
Application: DAF

FLEETGUARD: AD27746
HENGST:
MANN: TB1394/6x
BALDWIN:
DONALDSON: P951411



MGZ-003

OE NO.: 21267818
Size: $\Phi 140 \times 166$
Thread: M39*1.5-LH
Application: Volvo, Renault

FLEETGUARD: AD27748
HENGST:
MANN: TB 1394/5 x
BALDWIN:
DONALDSON: P951415

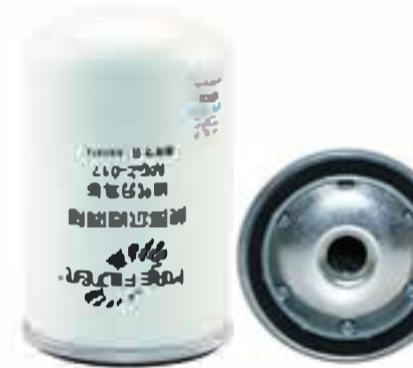

MGZ-017

OE NO.: 2120276
Size: $\Phi 79.5 \times 124$
Thread: M16x1.5
Application: CUMMINS, DONGFENG, C&C Trucks, Tractor

FLEETGUARD: AS2474
HENGST:
MANN:
BALDWIN:
DONALDSON:



MGZ-039

OE NO.: TB1374/4X
Size: $\Phi 140 \times 166$
Thread: M42*1.5-6H
Application: MercedesBenz, Renault

FLEETGUARD: AD27752
HENGST:
MANN: TB1374/4X
BALDWIN:
DONALDSON:

AIR FILTER



OE NO.: 21715813
Size:
Application: Volvo trucks

FLEETGUARD: AF26472M
HENGST: E767L
MANN: C3316302
BALDWIN: RS4642
DONALDSON: P606720

KU-33-013



OE NO.: 370754
Size:
Application: Scania Trucks

FLEETGUARD: AF4631
HENGST: E283L
MANN: C30880/2
BALDWIN: PA2801
DONALDSON: P771573

KT-30-021



OE NO.: 0040947404
Size: $\Phi 342(285) \times \Phi 128 \times 350$
Application: Mercedes-Benz Trucks

FLEETGUARD: AF25653
HENGST:
MANN: C29010
BALDWIN: RS5342
DONALDSON:

KU-27-013



OE NO.: 72214502
Size: $\Phi 54 \times 38$
Application: Case, J.C Bamford, Kobelco, Link-Belt, Volvo Excavators

FLEETGUARD: AF26675
HENGST: E1874L
MANN: C6006
BALDWIN: PA5316
DONALDSON: P502563

KU-05-002



OE NO.: 4379574M1
Size:
Application: John Deere Excavators, Loaders; New Holland Excavators

FLEETGUARD: AF4181
HENGST:
MANN:
BALDWIN: RS5782
DONALDSON: P611190

KU-21-004



OE NO.: 4379575M1
Size:
Application: John Deere Excavators, Loaders; New Holland Excavators

FLEETGUARD: AF4182
HENGST:
MANN:
BALDWIN: RS5783
DONALDSON: P611189

KU-13-005



OE NO.: 132151A1, 132149A1
Size:
Application: Case-International, John Deere, Steiger Equipment

FLEETGUARD: AF25460M, AF25461M
HENGST:
MANN:
BALDWIN: RS3718, RS3719
DONALDSON: P537778, P537779

KU-28-029



OE NO.: 86998333, 86998332
Size:
Application: Case-International Equipment

FLEETGUARD: AF25595, AF25596M
HENGST:
MANN:
BALDWIN: RS3926, RS3927
DONALDSON: P548900, P548901

KU-33-006



OE NO.: 11-9955
Size:
Application: THERMO KING

FLEETGUARD:
HENGST:
MANN:
BALDWIN:
DONALDSON:

WG-290



OE NO.: 17801-56010
Size:
Application: TOYOTA

FLEETGUARD:
HENGST:
MANN:
BALDWIN:
DONALDSON:

MGZ-022



OE NO.: 49088, 49089
Size:
Application: International Trucks

FLEETGUARD: AF26103, AF26268
HENGST:
MANN:
BALDWIN: RS4862, RS4863
DONALDSON: P613336, P613337

KU-30-013



OE NO.: AR70106, AR70107
Size:
Application: Hanomag, John Deere, Terex Equipment; R.V.I. Trucks

FLEETGUARD: AF1643, AF1644
HENGST:
MANN: C271318, C16200
BALDWIN: PA2461, PA2462
DONALDSON:

KT-26-011



OE NO.: 57MD320M
Size: $\Phi 235.7 \times 647.7$
Application: MACK TRUCKS

FLEETGUARD: AF26363
HENGST:
MANN:
BALDWIN: RS4634
DONALDSON: DBA5114

KU-23-003



OE NO.: 11-7400
Size: $\Phi 165 \times 264$
Application: THERMO KING

FLEETGUARD: AH1189
HENGST:
MANN: C17127
BALDWIN: PA2804
DONALDSON: D065008

KU-17-002



OE NO.: AH1198
Size: $\Phi 215 \times \Phi 63 \times 136$
Application: John Deere, Northern Lights

FLEETGUARD: AH1198
HENGST:
MANN:
BALDWIN: PA2825
DONALDSON: C085001

KU-22-015



OE NO.: 612501, 612502
Size: $\Phi 282 \times \Phi 167 \times 341 / \Phi 150 \times \Phi 110 \times 322$
Application: Agco, Massey Ferguson Tractors; Caterpillar Equipment

FLEETGUARD: AF25125M, AF25126M
HENGST: E591L, E591LS
MANN: C29840, CF1574
BALDWIN: RS3504, RS3505
DONALDSON: P532501, P532502

KU-28-008



OE NO.: 8-97062294-0
Size: $\Phi 235 \times \Phi 134 \times 289$
Application: Isuzu Trucks

FLEETGUARD: AF27693
HENGST:
MANN:
BALDWIN: RS5434
DONALDSON:

KU-24-003



OE NO.: 21115483
Size: $\Phi 331 \times \Phi 199 \times 415$
Application: Volvo Trucks with D13C Engine

FLEETGUARD: AF27834
HENGST: E1024L
MANN: C331460/1
BALDWIN:
DONALDSON: P951102

KU-33-003



OE NO.: E297L
Size: $\Phi 420 \times 255(13) \times 260$
Application: Mercedes-Benz Trucks, Vans

FLEETGUARD: AF25428
HENGST: E297L
MANN: C421404
BALDWIN: PA3838
DONALDSON: P780848

KT-41-001



OE NO.: E497L
Size: $\Phi 540(406) \times \Phi 222 \times 346$
Application: Mercedes-Benz Trucks

FLEETGUARD: AF26165
HENGST: E497L
MANN: C41001
BALDWIN: RS5362
DONALDSON: P785542

KU-41-001



OE NO.: AF977
Size: $\Phi 324(390) \times 168(10.5) \times 250$
Application: Mercedes-Benz Buses, Trucks, Vans

FLEETGUARD: AF977
HENGST: E276L
MANN: C33922
BALDWIN: PA2838
DONALDSON: P771583

KT-32-010



OE NO.: 17801-0C010
Size: $\Phi 222 \times \Phi 121 \times 174$
Application: Ford

FLEETGUARD: AF26501
HENGST: E1114L
MANN: C23107
BALDWIN:
DONALDSON:

KU-22-003



OE NO.: 41272124
Size: $\Phi 314 \times \Phi 217 \times 461$
Application: Iveco Trucks

FLEETGUARD: AF26241
HENGST: E681L
MANN: C321420/2
BALDWIN: R55356
DONALDSON: P785352

KU-31-004



OE NO.: A0040943504
Size: $\Phi 267 \times \Phi 170 \times 533$
Application: Mercedes-Benz Trucks

FLEETGUARD: AF26242
HENGST: E603L
MANN: C271320/3
BALDWIN: R55358
DONALDSON: P784457

KU-26-003



OE NO.: 6I2503, 6I2504
Size: $\Phi 277 \times \Phi 146 \times 417$ & $\Phi 151 \times \Phi 111 \times 393$
Application: FREIGHTLINER, CATERPILLAR, KOMATSU, JOHN DEERE

FLEETGUARD: AF25129M, AF25130M
HENGST: E808L, E808LS
MANN: CF281045, CF15136
BALDWIN: R53506, R53507
DONALDSON: P532503, P532504

KU-28-007



OE NO.: AF25064, AF1840
Size: $\Phi 198 \times \Phi 113 \times 378$ & $\Phi 111 \times \Phi 18 \times 373$
Application: IVECOMK, MANHOCL, MERCEDES-BENZ, FREIGHTLINER

FLEETGUARD: AF25064, AF1840
HENGST: E115L, E115LS
MANN: C20325/2, CF1000
BALDWIN: PA2405, PA2835
DONALDSON: P771561, P776695

KT-20-016



OE NO.: R53731
Size:
Application: Mitsubishi Trucks

FLEETGUARD: AF25365
HENGST:
MANN:
BALDWIN: R53731
DONALDSON: P536036

KU-23-019



OE NO.: R54806
Size:
Application: Mitsubishi Trucks

FLEETGUARD: AF27690
HENGST:
MANN:
BALDWIN: R54806
DONALDSON: P500191

KU-23-020



OE NO.: AF4060, AF1843
Size:
Application: DAF, Iveco, M.A.N., Mercedes-Benz, Scania Buses, Trucks

FLEETGUARD: AF4060, AF1843
HENGST: E117L, E117LS
MANN: C24650/6, CF1300
BALDWIN: PA2475, PA2814
DONALDSON: P181137, P776697

KT-24-001



OE NO.: AF472M, AF471
Size: $\Phi 308 \times \Phi 196 \times 473$ & $\Phi 214 \times \Phi 158 \times 450$
Application: RENAULT TRUCKS Magnum, KENWORTH, FREIGHTLINER

FLEETGUARD: AF472M, AF471
HENGST:
MANN: C311226, C19157
BALDWIN: PA3688, PA1880
DONALDSON: P181002, P119372

KT-30-002



OE NO.: C14200 & CF200
Size: $\Phi 124 \times \Phi 74 \times 326$ & $\Phi 67 \times \Phi 52 \times 304$
Application: Ahlmann, Massey Ferguson Tractors; Atlas Copco Compressors; Bomag Compactors; Melroe-Bobcat Lift Trucks

FLEETGUARD: AF26389 & AF26390
HENGST: E1600L & E1600LS
MANN: C14200 & CF200
BALDWIN: R53942 & R53943
DONALDSON: P778984 & P780024

KU-12-001



OE NO.: 135326205
Size: $\Phi 105 \times \Phi 61 \times 266$
Application: Caterpillar Generator Sets; Caterpillar, Lister-Petter Industrial Engines

FLEETGUARD: AF26659
HENGST:
MANN:
BALDWIN: R55449
DONALDSON: P505976

KU-10-001



OE NO.: 6I-2505, 6I-2506
Size: $\Phi 318 \times \Phi 208 \times 393$ / $\Phi 210 \times \Phi 156 \times 390$
Application: Caterpillar Equipment

FLEETGUARD: AF25135M, AF25136M
HENGST: E736L, E736LS
MANN: C321170, CF21239
BALDWIN: R53510, R53511
DONALDSON: P532505, P532506

KU-32-002



OE NO.: C29939 & C17149
Size: $\Phi 282 \times \Phi 170 \times 420$ & $\Phi 94 \times \Phi 70 \times 324$
Application: KENWORTH, FORD, RENAULT TRUCKS, IVECO, JOHN DEERE

FLEETGUARD: AF424M & AF820M
HENGST: E129L
MANN: CC29939 & C17149
BALDWIN: PA1885 & PA1893
DONALDSON: P181046 & P119373

KU-28-024



OE NO.: 11-9300
Size: $\Phi 127 \times \Phi 48 \times 251$
Application: THERMO KING

FLEETGUARD: AF25119
HENGST:
MANN:
BALDWIN: R55387 KIT
DONALDSON:

KU-19-002



OE NO.: 11-9059
Size: $\Phi 90 \times \Phi 45 \times 186$
Application: Thermo King

FLEETGUARD: AF25550
HENGST:
MANN: C946/2
BALDWIN: R53715
DONALDSON: P812440

KU-09-002



OE NO.: AT300487, AT314583
Size: $\Phi 225 \times \Phi 130 \times 425$ & $\Phi 182 \times \Phi 95 \times 403$
Application: John Deere Equipment

FLEETGUARD: AF25962, AF25963
HENGST:
MANN:
BALDWIN: R54992, R55329
DONALDSON: P613334, P613335

KU-26-002



OE NO.: 6I2499, 6I2500
Size: $\Phi 235 \times \Phi 131 \times 316$ & $\Phi 120 \times \Phi 80 \times 292$
Application: Caterpillar Equipment

FLEETGUARD: AF25111M, AF25112M
HENGST: E754L, E754LS
MANN: C24580, CF1273
BALDWIN: R53502, R53503
DONALDSON:

KU-24-011



OE NO.: 30-0047120
Size: $\Phi 87 \times \Phi 44 \times 266$
Application: Carrier-Transicold Refrigeration Units

FLEETGUARD: AF4219
HENGST:
MANN: C10006
BALDWIN: PA5584
DONALDSON: P611858

KU-12-002



OE NO.: 30-00430-23
Size: $\Phi 112 \times \Phi 60 \times 252$
Application: Carrier-Transicold Refrigeration Units

FLEETGUARD: AF25888
HENGST:
MANN:
BALDWIN: PA4802
DONALDSON: P621642

KU-11-001



OE NO.: 26510337, 26510338
Size: $\Phi 138 \times \Phi 80 \times 329$ / $\Phi 84 \times \Phi 65 \times 319$
Application: Carrier-Transicold Refrigeration Units

FLEETGUARD: AF25526, AF25484
HENGST: E571L, E571LS
MANN: C102102, CF850/2
BALDWIN: R53542, R53543
DONALDSON: P772579, P775300

KU-14-001



OE NO.: 26510342, 26510343
Size: $\Phi 163 \times \Phi 90 \times 352$ / $\Phi 90 \times \Phi 70 \times 334$
Application: Case, Caterpillar, Gehl, John Deere, New Holland, Vermeer, Volvo Equipment

FLEETGUARD: AF25557, AF25558
HENGST: E434L, E434LS
MANN: C173372, CF990/2
BALDWIN: R53544, R53545
DONALDSON: P828889, P829333

KU-16-002



OE NO.: 30-6009720
Size: $\Phi 104 \times \Phi 60 \times 222$
Application: Carrier-Transicold Refrigeration Units

FLEETGUARD: AF4336
HENGST:
MANN:
BALDWIN:
DONALDSON: P782868

KU-10-004



OE NO.: DZ9x259190121, DZ9x259190131
Size:
Application: SHACMAN

FLEETGUARD:
HENGST:
MANN:
BALDWIN:
DONALDSON:

KU-27-012



OE NO.: C31014
Size: $\Phi 304 \times \Phi 171 \times 450$
Application: Scania Trucks

FLEETGUARD: AF27940
HENGST: E1013L
MANN: C31014
BALDWIN: R530142
DONALDSON: P953211

KU-30-002



OE NO.: AF26249
Size:
Application: Volvo Equipment

FLEETGUARD: AF26249
HENGST:
MANN: C301345
BALDWIN: R55332
DONALDSON:

KU-30-027



KU-33-001

OE NO.: C321500
Size: $\Phi 335 \times 403 \times \Phi 204 \times 419$
Application: Volvo Trucks

FLEETGUARD: AF25238
HENGST: E316L
MANN: C321500
BALDWIN: PA3767
DONALDSON: P778779



KU-15-001

OE NO.: C15300, CF300
Size: $\Phi 150 \times \Phi 83 \times 358 / \Phi 76 \times \Phi 61 \times 342$
Application: J.C. Bamford, Massey Ferguson, Volvo Equipment

FLEETGUARD: AF26391, AF26392
HENGST: E1700L, E1700LS
MANN: C15300, CF300
BALDWIN: R53920, R53921
DONALDSON: P778989, P780030



MKF-007

OE NO.: 82988916, 82988917
Size: $250 \times 148 \times 180$ & $108 \times 210 \times 65$
Application: Case, CaseIH, J.C. Bamford, John Deere, New Holland Equipment

FLEETGUARD: AF26656, AF26655
HENGST:
MANN: CP25150, CF2120
BALDWIN: CA5450, PA5451
DONALDSON: P608533, P600975



MKF-045

OE NO.: 2515573C1, 2515575C2
Size: $603.5 \times 98.7 \times 235.9$
Application: 2017+ International LT and RH Series Trucks

FLEETGUARD:
HENGST:
MANN:
BALDWIN:
DONALDSON: P643132, P643313



KU-26-004

OE NO.: 81084050021, 81084050017
Size: $\Phi 267 \times \Phi 159 \times 509 / \Phi 158 \times \Phi 94 \times 372$
Application: M.A.N. Trucks

FLEETGUARD: AF25894, AF25896
HENGST: E428L01, E428LS
MANN: C271250/1, CF1640
BALDWIN: RS4971, RS5361
DONALDSON: P782936, P782937



KU-16-003

OE NO.: C16400, CF400
Size: $\Phi 158 \times \Phi 94 \times 372 / \Phi 85 \times \Phi 69 \times 358$
Application: Deutz, DeutzFahr, Fendt, Gehl, Massey Ferguson Tractors; JCB Excavators; Loaders; Terex Lift Trucks

FLEETGUARD: AF26393, AF26394
HENGST: E1800L, E1800LS
MANN: C16400, CF400
BALDWIN: R53922, R53923
DONALDSON: P778972, P780012



MKF-061

OE NO.: 2277448, 2277449
Size: $226 \times 156 \times 170 / 209 \times 142 \times 45$
Application: Caterpillar Crawler Tractors, Loaders

FLEETGUARD: AF26247, AF26248
HENGST:
MANN: CP23210, CF2135
BALDWIN:
DONALDSON: P608766, P785965



MKF-015

OE NO.: AF26155, AF26156
Size: $298 \times 107 \times 40, 326 \times 138 \times 283$
Application: John Deere Tractors

FLEETGUARD: AF26155, AF26156
HENGST: E712LS, E711L
MANN: CF30100, CP33530
BALDWIN: PA4704, CA4703
DONALDSON: P606121, P606120



KU-28-005

OE NO.: 40940204
Size: $\Phi 345 \times 285 \times \Phi 128 \times 405$
Application: MercedesBenz

FLEETGUARD: AF25476
HENGST: E314L
MANN: C291219/1
BALDWIN: R55343
DONALDSON: P781350



KU-30-017

OE NO.: AF25313
Size: $\Phi 304 \times \Phi 169 \times 528$
Application: Scania Trucks

FLEETGUARD: AF25313
HENGST: E1033L
MANN: C301500
BALDWIN: R53726
DONALDSON: P778336



MKF-014

OE NO.: CA4700
Size: $250 \times 306 \times 203$
Application: Freightliner Buses, Trucks

FLEETGUARD: AF26154
HENGST:
MANN:
BALDWIN: CA4700
DONALDSON: P607955



MKF-060

OE NO.: C30400/4, CF2631
Size: $310 \times 175 \times 250$
Application: Caterpillar Equipment

FLEETGUARD: AF25163, AF4457
HENGST: E1766L, E1766LS
MANN:
BALDWIN: PA5289, PA5290
DONALDSON: P639058, P959052



MKF-021

OE NO.: P621725
Size:
Application: Kenworth, Peterbilt

FLEETGUARD:
HENGST:
MANN:
BALDWIN:
DONALDSON: P621725



MKF-018

OE NO.: P611696
Size:
Application: Kenworth

FLEETGUARD:
HENGST:
MANN:
BALDWIN: CA5500
DONALDSON: P611696



MKF-038

OE NO.: C50004/1
Size:
Application: Mercedes-Benz

FLEETGUARD: AF4250
HENGST: E1059L
MANN: C50004/1
BALDWIN: CA30104
DONALDSON:



MKF-049

OE NO.: FA1778
Size: $300 \times 190 \times 230$
Application: Ford Excursion, Super Duty Trucks all with 6.0L Turbo Diesel Engine

FLEETGUARD: AF26152
HENGST:
MANN:
BALDWIN: P603577
DONALDSON:



MKF-026

OE NO.: 03-42776-010
Size:
Application: Freightliner Cascadia

FLEETGUARD:
HENGST:
MANN:
BALDWIN:
DONALDSON:



MKF-048

OE NO.: AF27879
Size: $665 \times 133 \times 236$
Application: Freightliner

FLEETGUARD: AF27879
HENGST:
MANN:
BALDWIN:
DONALDSON: P618478



MKF-057

OE NO.: FA1927
Size:
Application: Ford Super-Duty Trucks with (6.7L) Engines

FLEETGUARD: AF4286
HENGST:
MANN:
BALDWIN: PA10061
DONALDSON:



MKF-059

OE NO.: ML242294
Size: $265 \times 165 \times 135$
Application: Mitsubishi

FLEETGUARD:
HENGST:
MANN: CP25001
BALDWIN:
DONALDSON: P636991



MKF-003

OE NO.: P608666
Size: $187 \times 340 \times 211$
Application: Agco, Caterpillar, Challenger, John Deere, Massey Ferguson Equipment; Ford, IHC Trucks

FLEETGUARD: AF27876
HENGST:
MANN: CP34360
BALDWIN: CA5514
DONALDSON: P608666



MKF-022

OE NO.: P608676+P601560
Size: $285 \times 331 \times 204 / 317 \times 190 \times 40$
Application: Ag-Chem, Agco, Caterpillar, Challenger, JCB, John Deere, Massey Ferguson, Valtra Equipment

FLEETGUARD: AF4206+AF4199
HENGST:
MANN: CP33540+CF3240
BALDWIN: CA5788+PA5515
DONALDSON: P608676+P601560



MKF-063

OE NO.: 479-8989
Size: $344 \times 201 \times 288$
Application: Caterpillar

FLEETGUARD:
HENGST:
MANN:
BALDWIN:
DONALDSON:



MKF-072

OE NO.: P608665
Size:
Application: Valtra Tractors

FLEETGUARD: AF4203
HENGST:
MANN: CP33280
BALDWIN: CA5278
DONALDSON: P608665



OE NO.: P637454
Size:
Application: Kenworth T680, T800;
Peterbilt 579 Trucks
FLEETGUARD:
HENGST:
MANN:
BALDWIN: PA32003
DONALDSON: P637454

MKF-078



OE NO.: 17801-78100
Size:
Application: Hino
FLEETGUARD:
HENGST:
MANN:
BALDWIN:
DONALDSON:

MKF-023



OE NO.: ABP N10G 91 559
Size: 270*270*25
Application: Freightliner
FLEETGUARD: AF26235
HENGST: E3920L1
MANN:
BALDWIN:
DONALDSON: P609422

MKB-042



OE NO.: CAF 24000
Size: 235*323*28
Application: Volvo
FLEETGUARD: AF26405
HENGST:
MANN: CU3161
BALDWIN: PA4681
DONALDSON: P606555

MKB-054



OE NO.: A3212C
Size: 360*260*50
Application: Buick, Cadillac, Chevrolet,
Traverse, GMC
FLEETGUARD:
HENGST:
MANN:
BALDWIN: PA10076
DONALDSON:

MKB-074



OE NO.: A3244C
Size: 320*250*65
Application: Cadillac, Chevrolet,
Silverado, GMC, Sierra
FLEETGUARD:
HENGST:
MANN:
BALDWIN: PA10417
DONALDSON:

MKB-075

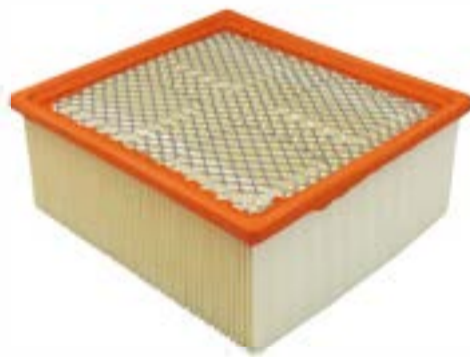

OE NO.: 53034051A8
Size:
Application: 2007-2023 Dodge Ram
2500 3500 4500 5500
FLEETGUARD: AF27684
HENGST:
MANN:
BALDWIN: PA4318
DONALDSON:

MKB-091



OE NO.: 17801-0L040
Size:
Application: Lexus GX460; Toyota
4Runner, FJ Cruiser
FLEETGUARD: AF4276
HENGST:
MANN: C33017
BALDWIN: PA4435
DONALDSON:

WG-087



OE NO.: 172205BAA00
Size: 235 * 183 * 46
Application: 2016-20 Honda Civic
FLEETGUARD:
HENGST:
MANN:
BALDWIN: PA10059
DONALDSON:

MKB-048



OE NO.: 8856837020
Size: 184 * 180 * 30
Application: Scion F R-S
FLEETGUARD: AF55837
HENGST:
MANN: CU1827
BALDWIN: PA10157
DONALDSON:

MKI-010



OE NO.: 81 61910-0044
Size: 357*160*37
Application: M.A.N. Trucks
FLEETGUARD: AF56116
HENGST: E6955LC
MANN: CUK36003
BALDWIN:
DONALDSON:

MKB-108



OE NO.: 81 61910-0019
Size: 465*180*70
Application: M.A.N. Trucks
FLEETGUARD: AF55719
HENGST: E954LC
MANN: CUK4795
BALDWIN: PA5477
DONALDSON: P786092

MKB-014

ASSEMBLY



OE NO.: ULPK0040
Size: 216*173*184
Thread:
Application: PERKINS

MCH-004



OE NO.: ULPK0041
Size: 258*173*184
Thread:
Application: Perkins

MCH-003



OE NO.: 4132A018
Size: 184*165*260
Thread:
Application: Perkins

MCH-002



OE NO.: 4132A016
Size: 184*165*216
Thread:
Application: Perkins

MCH-001



OE NO.: R13T
Size: 81*81.6*207
Thread:
Application: Racor

MCB-241-000



OE NO.: R12T
Size: Φ100*170
Thread: M18*1.5
Application: Marine

MCB-146-200



OE NO.: 1000FG
Size: 146*161*559
Thread: 7/8"-14
Application: Special For Heavy Truck
refitting

MKC11-002



OE NO.: 900FG
Size: Φ161*146*423
Thread:
Application: Special For Heavy Truck
refitting

MKC11-001

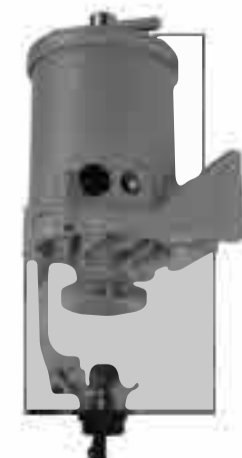

OE NO.: 500FG
Size: 147*292
Thread:
Application:

MKC0B-001



OE NO.: 600FG
Size:
Thread:
Application:

MKC11-011



OE NO.: 500FG Double
Size:
Thread:
Application:

MKC11-017



OE NO.: 900FG Double
Size:
Thread:
Application:

MKC11-001



OE NO.: LG9704552581/A
Size: 209*152*316
Thread:
Application: SINOTRUK HOWO

MCK07-003



OE NO.: EZ9A049553006
Size:
Thread:
Application:

MCE-088-000A



OE NO.: 1000FG Double
Size:
Thread:
Application:

MKC11-004



OE NO.: 900FG Double
Size:
Thread:
Application:

MGZ-008



OE NO.: EZ9A049553007
Size:
Thread:
Application:

MCE-088-000B



OE NO.: EZ9A049553008
Size:
Thread:
Application:

MCE-088-000C



OE NO.: PL420
Size:
Thread:
Application:

MCE-002



OE NO.: R60P
Size:
Thread:
Application:

MCE-025



OE NO.: S3213
Size:
Thread:
Application: Marine Outboard Motor

MCC-270-000



OE NO.: 32-925694A
Size: $\Phi 131.5 \times 257.6$
Thread:
Application: JCB

MCB-092-000



OE NO.: R90P
Size:
Thread:
Application:

MCE-015



OE NO.: R90-MER01
Size:
Thread:
Application:

MCE-036



OE NO.: B10-AL
Size: $\Phi 105 \times 253.5$
Thread:
Application:

MKC07-002



OE NO.: 0000907350
Size:
Thread:
Application: MERCEDES-BENZ

MKC07-008



OE NO.: LG9704550028/A
Size: 276*108*158
Thread:
Application: SINOTRUK HOWO

MCC-241A-100



OE NO.: LG9704550139/A
Size: 276*108*158
Thread:
Application: SINOTRUK HOWO

MCC-239A-100



OE NO.: LG9704550254/B
Size: 276*108*158
Thread:
Application: SINOTRUK HOWO

MCC-240A-100



OE NO.: LG9704552631/A
Size: 174*159*316
Thread:
Application: SINOTRUK HOWO

MKC07-004

ACCESSORY

ALUMINUM BASE



OEM:
A0004771302



MGZ- 008
OEM:
T250W



LZ-009
OEM:
PL420
PL270



LZ-001
OEM:
PL420
PL270



LZ-005
OEM:
R120P
R90P
R60P
R90-MER-01



M-LZ-010
OEM:



M-LZ-011
OEM:



M-LZ-012
OEM:



M-LZ-013
OEM:

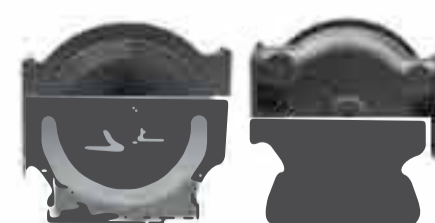

M-LZ-014
OEM:



M-LZ-015
OEM:



M-LZ-016
OEM:



M-LZ-017
OEM:

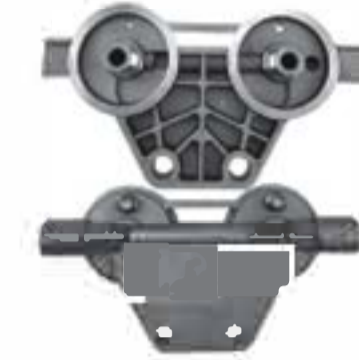

M-LZ-018
OEM:



M-LZ-019
OEM:

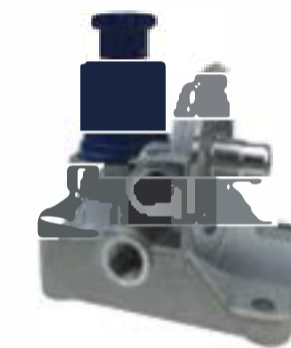

M-LZ-020
OEM:



M-LZ-021
OEM:



M-LZ-022
OEM:



M-LZ-023
OEM:



M-LZ-024
OEM:



M-LZ-025
OEM:



M-LZ-026
OEM:



M-LZ-027
OEM:



M-LZ-028
OEM:



M-LZ-029
OEM:



M-LZ-030
OEM:



M-LZ-031
OEM:



M-LZ-032
OEM:



M-LZ-033
OEM:

WATER BOWL



OEM:
PL420
PL270



OEM:
PL420 bowl with water level sensor
1450194
ITEM NO.:
PL420
PL270



OEM:
PL420 bowl with Flat Head
ITEM NO.:
PL420
PL270



OEM:
PL420 bowl with red plug
ITEM NO.:
PL420
PL270



OEM:
PL420 heating bowl with induction (new white)
ITEM NO.:
PL420
PL270



OEM:
PL420 heating bowl with induction (Red plug)
ITEM NO.:
PL420
PL270



OEM:
PL420 heating bowl (new version) (red)
ITEM NO.:
PL420
PL270



OEM:
PL420 heating bowl (New Flat Head)
ITEM NO.:
PL420
PL270



OEM:
PL420 heating bowl with fuse (old version)
ITEM NO.:
PL420
PL270



OEM:
O205 Bowl with heating
ITEM NO.:
R60P / R60T
R90P / R90T
R120P / R120T
8159975



OEM:
0205 heating bowl
with Induction
ITEM NO.:
R60P / R60T
R90P / R90T
R120P / R120T
8159975



OEM:
0205 heating bowl with
thick Flat Head
ITEM NO.:
R60P / R60T
R90P / R90T
R120P / R120T
8159975



OEM:
0205 heating bowl with
induction (white)
ITEM NO.:
R60P / R60T
R90P / R90T
R120P / R120T
8159975



OEM:
0205 heating bowl with
thick round head induction
ITEM NO.:
R60P / R60T
R90P / R90T
R120P / R120T
8159975



OEM:
1105010-2007-C00
A M.3.03



OEM:
FADWE J6 Bowl
ITEM NO.:
1105010-2007-CXX



OEM:
3943382
ITEM NO.:
R60P / R60T
R90P / R90T
R120P / R120T
8159975



OEM:
W1269-061



OEM:
19816 Bowl (macropore)
ITEM NO.:
FS1240
FS1242
FS19816



OEM:
FS19816 Bowl with heating
ITEM NO.:
FS19816



OEM:
19816 Bowl with heating
(grey)



OEM:
301 Bowl
ITEM NO.:
SF90P
60205961
PL420



OEM:
YCQ-6935-6200



OEM:
YCQ-6874-6000



OEM:
1000FG Bowl (Ostiole)



OEM:
1000FG Bowl



OEM:
DX300
DX600
DX800



OEM:
ISUZU S23401-1790



OEM:
120 Bowl with heating
ITEM NO.:
0004772016



OEM:
A 0004772516
ITEM NO.:
R90-MER-01



OEM:
FS19816 Bowl
ITEM NO.:
FS1240
FS1242
FS19816



OEM:
FS19816 Bowl with white
plug
ITEM NO.:
FS1240
FS1242
FS19816



OEM:
R90-MER-01
R120P
R120T
R160T